



RPM2A

Issue 1, 01 August 2012

UHF Radio Packet Modem

The UHF Radio Packet Modem (RPM2A) is a low cost intelligent radio packet modem that enables a two way radio network/link to be simply implemented between a number of digital devices. The RPM2A uses addressable data packets with error checking, packet acknowledgements and retransmissions to achieve a reliable transparent wireless data link. Built for ease of use and rapid installation, the serial interface ensures direct connection to microprocessors or to RS232 port via RS232 driver while remote configuration enables post installation setup of the modem.

Features

- Addressable point-to-point
- Point-to-Multipoint and broadcast modes
- Inverted RS232 interface at 5V or 3VCMOS level
- DTE speed 600-115200bps
- Overall throughput: 17kbps with ACK
28kbps without ACK
- Single 5V or 3V supply
- 15mA during data streaming at maximum rate
- Flow control – Hardware (CTS), None0
- Available on 433.92MHz or 434.42MHz
- Usable range up to 300m
- Built-in command line configuration
- Built-in RF link diagnostics
- Remote over-air unit configuration
- Low operating current, Auto standby mode
- Conforms to European ETSI EN 300 220-3 and EN 301 489-3
- Dimensions: 39mm X 23mm X 10mm



Figure 1: RPM2A-433-17

Applications

- Telemetry and telecontrol
- EPOS equipment, barcode scanners, belt clip printers, stock control, job allocation
- Remote data acquisition system, data loggers
- In-building, environmental monitoring and control systems
- High-end security and alarm signalling
- Automated Monitoring and Control Systems
- Fleet management, vehicle data acquisition

Evaluation platforms: RPM/SPM Eval kit

INTRODUCTION

The *RPM2A* is a self-contained Radio Packet Modem module that requires only a simple antenna, 5V supply and a serial I/O port on a host microcontroller or PC.

The module provides all the RF circuits and processor intensive low level packet formatting and packet recovery functions required to inter-connect any number of devices with serial port in a radio network.

A continuous stream of serial data downloaded by a Host microcontroller into the *RPM2A* serial receive buffer is transmitted by the *RPM2A*'s transceiver and will "appear" in the serial buffer of the addressed *RPM2A* within radio range.

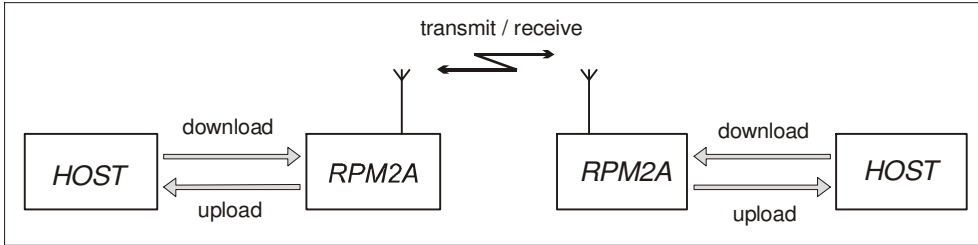

Figure 2: Point to point wireless link with *RPM2A* + Host microcontroller

1. FUNCTIONAL DESCRIPTION

The *RPM2A* is a connection oriented modem module for sending and receiving serial data via an RF communications link.

The *RPM2A* handles all necessary protocol related functions of validation and retries to ensure error free and uninterrupted data is sent over the communications link. All data transfers between a pair of *RPMS* are fully acknowledged, thus preventing the loss of data. Bit coding and checksums are used on the data packets to ensure the validity of the received data at the remote end.

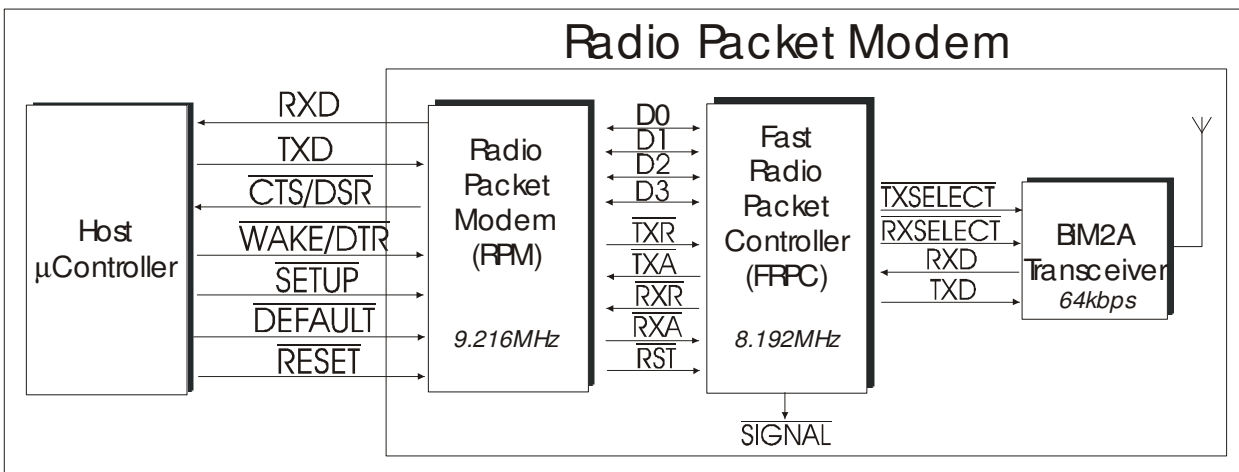

Figure 3: *RPM2A* block diagram

1.1 OPERATING STATES

The RADIO PACKET MODEM has three normal operating states:

- *SHUTDOWN*
- *STANDBY*
- *CONNECTED*

SHUTDOWN

The *SHUTDOWN* state is entered by asserting the $\overline{\text{WAKE/DTR}}$ input pin high (Vcc). It effectively forces the RPM2A into a suspended state. Communications cannot be made with the RPM2A in this state. $\overline{\text{WAKE/DTR}}$ pin should be pulled Low by host or connected to 0V to Enable the RPM2A.

STANDBY

Immediately after power up and during normal operation, the RPM2A will automatically enter standby mode where it is waiting for a connection request from a remote RPM2A module.

While in this mode a remote connection request can be received which will place the RPM2A into a connected state allowing it to then start receiving data from the remote unit. The connected host device can also send data to the RPM2A via the serial interface which will force the module to send a connection request to the remote RPM2A module, thus effectively setting up a logical connection between two units and allowing data to be transferred.

CONNECTED

On receipt of a connection request from a remote unit, the RPM2A immediately enters a connected state. This effectively allows the RPM2A modems to start sending and receiving data.

In-coming data is sent to the host via the serial port in the same form as it was given to the remote RPM2A module.

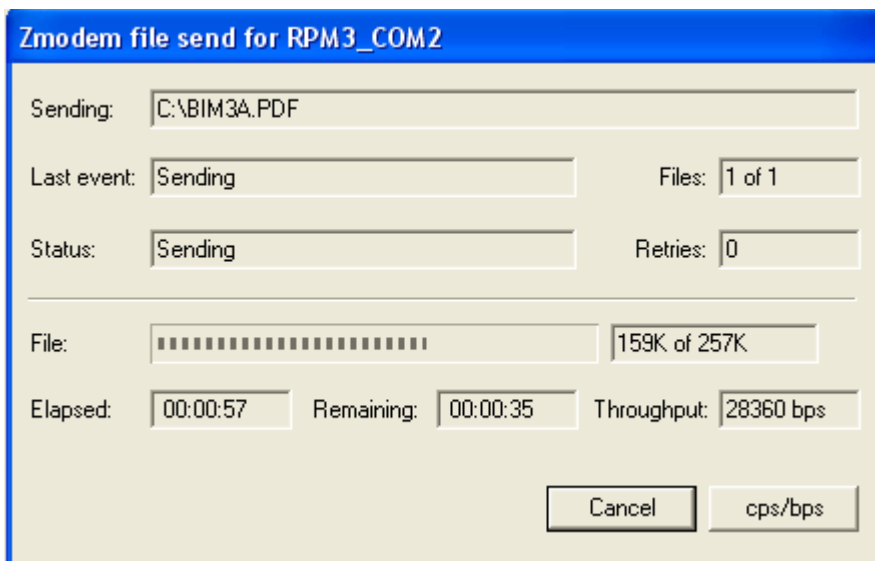

Figure 4: RPM2A transmitting data at 28kbps during ZMODEM file transfer to a remote RPM2A

2 The Host Interface

2.1 SIGNALS

The connection to the RPM2A is a full duplex serial interface supporting baud rates from 600bps to 115200bps. Additional control signals are provided to assist in flow control, configuration and power saving in the RPM2A.

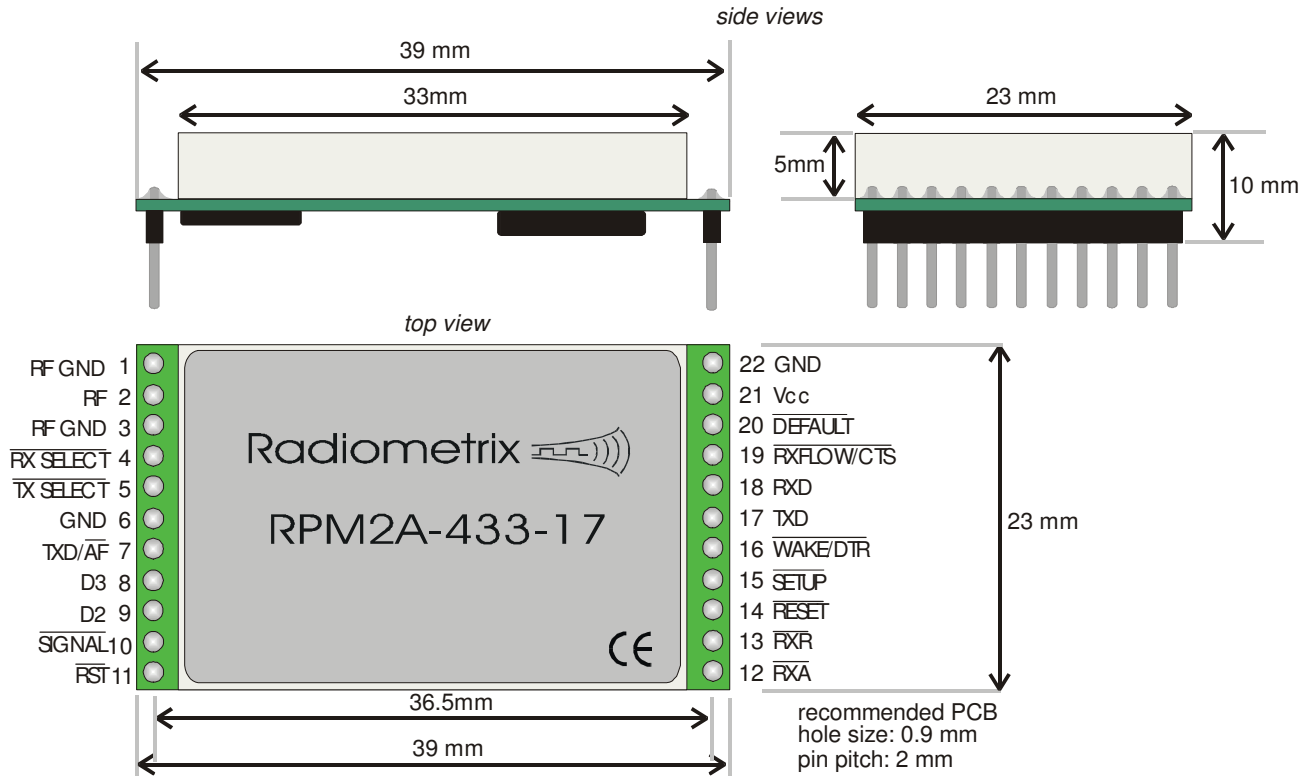

Figure 5: Physical dimensions and pinouts

Pin name	Pin	Pin Function	In/Out	Description
RF GND	1, 3	RF signal ground		BNC casing/coax braid connection
RF	2	RF signal	Input or Output	Antenna pin/coax core connection
RXSELCT	4	Receiver Select	Input or Output	Internal RF Receiver Enable to BiM2A or RF Receiver Active Indicator
TX SELECT	5	Transmitter Select	Input or Output	Internal RF Transmitter Enable to BiM2A or RF Transmitter Active Indicator
TXD/AF	7	Transmitted Data or demodulated signal	Input or Output	Transmitted Packetised Data to BiM2A Analogue Demodulated signal from BiM2A
D3	8	FRPC Data line	NC	Internal data line between RPM and FRPC
D2	9	FRPC Data line	NC	Internal data line between RPM and FRPC
SIGNAL	10	Preamble Detect	Output	Valid preamble indicator
RST	11	FRPC reset	NC	Resets FRPC which also isolates BiM2A
RXA	12	Receive Acknowledge	NC	RPM to FRPC download Request Acknowledge
RXR	13	Receive Request	Output	Valid Data packet indicator
RESET	14	Reset	Input	Hardware reset of the RPM2A
SETUP	15	Enter Setup	Input	Enter RPM2A configurator after a RESET
WAKE/DTR	16	Wake or Shutdown	Input	Wakes RPM2A when low, shuts down when high
TXD	17	Serial transmitted data	Input	Host (DTE) to RPM2A serial transmit data
RXD	18	Serial Received data	Output	RPM2A to host (DTE) serial received data
CTS	19	Clear To Send	Output	Hardware flow control of data from host (DTE)
DEFAULT	20	Force 9600bps	Input	Force the RPM2A serial interface to 9600bps
VCC	21	Vcc Supply	Input	+5VDC or +3VDC regulated supply
GND	6, 22	Ground	-	Supply Ground internally connected to GND

- Notes:**
1. RXD/TXD lines are true data
 2. Active low SETUP, DEFAULT inputs require external 10kΩ pull-up to VCC.
 3. Logic levels are 5V CMOS unless 3V variant is used.
 4. WAKE pin should be pulled to ground if DTE cannot provide DTR signal
 5. TXSELECT, RXSELECT, SIGNAL, RXR, CTS can be connected to LEDs via 1kΩ series resistors

2.2 RADIO PACKET MODEM RESET

RESET

The Reset signal is internally pulled up to Vcc via a 10kΩ resistor. A reset aborts any transfers in progress and restarts the RPM2A.

HOST DRIVEN RESET

Minimum low time: 1.0 μs, after reset is released (returned high). The host should allow a delay 1ms after reset for the RPM2A to initialise itself.

2.3 HOST TO RADIO PACKET MODE DATA TRANSFER

Data is transferred between the RPM2A and the HOST using an asynchronous serial protocol. The default protocol settings are 8 data bits, no parity and 1 stop bit (8n1). The baud rate setting for the serial interface is user settable from 600bps to 115200bps.

TXD

Data from the connected host (DTE) is received by the RPM2A through TXD pin.

CTS

A single handshake line, **CTS**, controls the flow of data into the RPM2A. The serial receive buffer of the RPM2A is 96 bytes deep. The **CTS** will be asserted High (VCC) by the RPM2A when the receive buffer hits approximately 66% full. It is advisable to limit the number of characters sent to the RPM2A after the **CTS** control line is asserted. This will help to reduce the possibility of lost data due to internal buffer overruns in the RPM2A. The RPM2A will clear the **CTS** when the internal serial receive buffer falls below 33% full.

RXD

Upon the RPM2A receiving data from a remote unit, the received data is sent to the connected host (DTE) device through the RXD pin..

2.4 ENTERING RADIO PACKET MODEM CONFIGURATOR

Configuring the RPM2A is accomplished by using a built-in command line configurator. The configurator is entered by asserting the *SETUP* input of the RPM2A while resetting the RPM2A.

SETUP

Holding *SETUP* low during a reset cycle will force the modem into the configurator. The state of this input is checked while the RPM2A starts up from either power on or reset.

HOST DRIVEN SETUP

The Setup pin may either be driven by the host (recommended) to enable host controlled configuration of the RPM2A or pulled up to Vcc via a suitable pull-up resistor (10kΩ).

2.5 FORCING DEFAULT SERIAL BAUD RATE

Asserting this pin low forces the RPM2A to start-up with a default baud rate of 9600bps, 8 data bits, one stop and no parity.

DEFAULT

During a *RESET* the *HOST* must hold *DEFAULT* low to force the RPM2A serial interface to default to 9600bps. This is ideal if the serial baud rate has been forgotten or incorrectly set.

HOST DRIVEN DEFAULT

The *DEFAULT* pin may either be driven by the host (recommended) or pulled up to Vcc via a suitable pull-up resistor (10kΩ).

2.6 FORCING RADIO PACKET MODEM INTO SLEEP MODE

Asserting the *WAKE* input high forces the modem into a low power sleep mode. This effectively shuts down the RPM2A and prevents it from sending or receiving any data. It is a method for conserving power when the modem is not required.

WAKE / DTR

During normal operation *WAKE* pin can be pulled high to force the RPM2A to shutdown into low power sleep mode.

HOST DRIVEN WAKE

The *WAKE* pin may either be driven by the host (recommended) or pulled Low to 0V.

TECHNICAL SPECIFICATION

General	
Operating Voltage	5VDC or 3VDC
Operating Current (@10mW)	
ACKMODE ON Transmitting	Average 15mA (Data streaming)
Receiving	Average 15mA (Data streaming)
ACKMODE OFF Transmitting	Average 14mA (Data streaming)
Receiving	Average 15mA (Data streaming)
Auto-Standby	4mA (Waiting for Connection)
Power-down	70µA
Standard Operating frequency	
	433.92MHz
TX spectral bandwidth @ -40dBc	
	250kHz
Operating Temperature	
	-20°C to +70°C
Configuring options	
	Built-in command line configurator
Interface	
Serial Interface	Inverted RS232 at 5V or 3V CMOS level
Serial Protocol	8 data/1 stop/no parity
Serial Signals	RXD, TXD, CTS, WAKE
Power down Control	Via WAKE/DTR signal
Serial Handshaking	Selectable as CTS signal or none
DTE Interface Speed	600/1200/2400/4800/9600/19200/38400/57600/115200 bps
Air Interface Speed	64kbps
Overall throughput – Acknowledged	17kbps (max) 3.6kbps (slots) 1.8kbps (slotsw)
– Unacknowledged	28kbps (max) 3.6kbps (slots) 1.8kbps (slotsw)
Receiver	
Sensitivity	-100dBm for 1ppm BER
LO leakage (conducted)	-110dBm (max)
Transmitter	
Output Power (typical)	+10dBm (RPM2A) +14dBm (RPM2H) +20dBm (RPM2EH)
Spurious Emissions	-40dBm max

Note:

1. RPM2A uses BiM2A (64kbps UHF Wide Band FM) transceiver for its RF interface. RPM2H and RPM2EH are high power variant based on the BiM2H and BiM2EH transceivers respectively. Please refer to BiM2A data sheet for further details on the RF specification.
2. Typical current ratings are given only for the RPM2A based on the BiM2A which consumes 14mA on transmit and 11mA on receive whereas high power BiM2H and BiM2EH consumes 25mA and 40mA on transmit respectively. Hence, current consumption will be slightly higher for the high power modem variants

3.0 RADIO PACKET MODEM CONFIGURATION

3.1 ENTERING THE CONFIGURATOR

The RPM2A is configured by entering the built-in software configurator. Current argument can be displayed by entering parameter / command without argument

3.2 USER CONFIGURABLE PARAMETERS

CONFIG	Display a list of the current RPM2A configuration. This will also set <i>FLOW</i> control to none to enable simple 3 wire serial communication
Valid range	None
DEFAULT	Set all RPM2A configuration settings to their factory default values.
Valid range	None
RESET	Exit the modem and force a software reset. Any changed parameters will take effect after the modem has restarted. When exiting the configurator, the <i>HOST</i> device must ensure the <i>SETUP</i> pin is high otherwise the configurator will be re-entered after the reset.
Valid range	None
UNIT	Sets the unit number. Two RPM2A modules can communicate with each other provided they have matching Unit numbers and Site codes.
default	0
Valid range	0 to 15
SITE	Sets the Site address The site number is used to distinguish between groups of operating modems. The site code is an address extension to the unit number.
default	0
valid range	0 to 7
ADDR	Updates the unit number value. This command is used for changing the unit number in RAM without updating the unit number stored in EEPROM. This enables the <i>RPM2A</i> to support point-to-multipoint communications. Upon using this command the configurator is exited and the modem operation is resumed. The modem is not reset when the configurator is exited.
default	0
Valid range	0 to 15
BAUD	Sets the host interface baud rate. The changed baud rate will take effect after resetting the RPM2A.
default	9600
valid range	600, 1200, 2400, 4800, 9600, 19200, 38400, 57600, 115200
THRUPUT	Sets the on-air data throughput. Three possible settings are provided. max: sets the maximum data throughput of the RPM2A. slots: effectively reduces the on-air throughput. This opens up 'time slots' allowing other RPM2A pairs, operating within close proximity, equal opportunity to transmit data. slotsw: increases the 'time slots' even further to allow more RPM2A pairs to operate.
default	max
valid range	max, slots, slotsw

FLOW	<p>Sets the serial flow control between the host and RPM2A.</p> <p>Using no flow control enables the RPM2A to be used with a 3 wire serial link (TXD, RXD, GND). Care must be taken in order to prevent overflowing the 96 byte serial receive buffer in the RPM2A.</p> <p>Using hardware flow control enables the RPM2A to control the flow of serial data being received.</p> <p>default none valid range hw, none</p>
SERDLY	<p>Sets the serial data receive to packet transmit delay.</p> <p>When the RPM2A receives the first byte of data from the host, it starts a timer running. Either a full buffer of data to send or a timeout of this timer will allow the packet to be transmitted.</p> <p>Fine tuning this delay for the baud rate the RPM2A is operating at can significantly increase throughput while reducing unnecessary transmissions.</p> <p>default 2 (x10ms) valid range 2 to 255 (x10ms)</p>
SHDN	<p>Sets the action of the WAKE input.</p> <p>Setting shutdown to <i>ON</i> will cause the RPM2A to monitor the <i>WAKE</i> input. When <i>WAKE</i> is taken high the RPM2A will be forced into low power sleep mode, thus reducing current consumption. Subsequently lowering the <i>WAKE</i> input will bring the RPM2A out of low power sleep mode.</p> <p>SHDN should be set to <i>OFF</i> or <i>WAKE</i> pin should be pulled Low when the host (DTE) cannot provide DTR control signal to wake RPM2A in a 3-wire serial interface.</p> <p>default On valid range on, off</p>
RETRY	<p>Sets the number of data retry attempts.</p> <p>RF interference can cause a transmitted data packet to be lost or corrupt on reception. If this happens the RPM2A will retransmit any unacknowledged transfer. The transmission will be retried the specified number of times before the link to the remote unit is considered 'lost' and the data purged.</p> <p>default 5 valid range 1 to 63</p>
STRMSG	<p>Enables the startup message.</p> <p>The startup message is enabled by default, thus giving an immediate indication of the operation of the RPM2A. The message can be disabled prior to deployment of the RPM2A module.</p> <p>default On valid range on, off</p>
ACKMODE	<p>Enables transfer acknowledgements.</p> <p>This function enables packet transfer acknowledgements to be returned for every outgoing packet. Packet acknowledgements aid in the delivery of error free and consistent data transfers between a pair of modems. Disabling the acknowledgements results in higher data throughput between modems, but does not protect against lost data due to RF interference. It should be disabled while using RPM2A in a broadcast mode.</p> <p>default On valid range on, off</p>
REMOTE	<p>Enables remote configuration.</p> <p>Over-air remote configuration of a RPM2A module is possible once it has been enabled. The remote command is used to send remote configuration commands. See the following chapter for a overview of remotely configuring a RPM2A module.</p> <p>default On valid range on, off</p>
RADAR	<p>Starts the radar test.</p> <p>Used as a range or confidence test between RPM2A modules within the same site.</p> <p>parameter Unit number between 0 and 15.</p>

To configure the RPM2A the HyperTerminal should be set with the following settings.

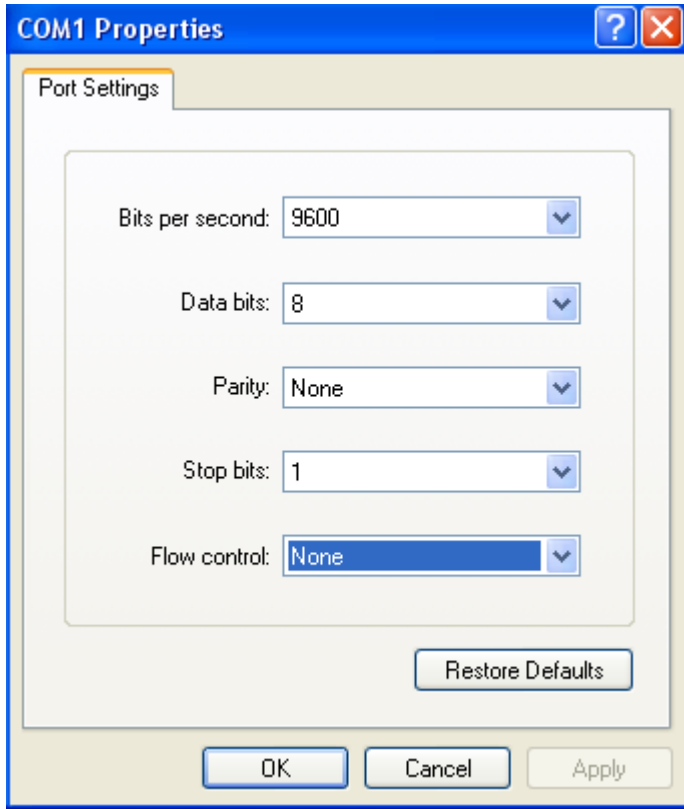

Figure 6: Serial Port settings to use RPM2A Configurator

Hardware flow control should be disabled. Default baud rate of the RPM2A is 9600bps. However if the default baud rate of the RPM2A is changed then the baud rate of the HyperTerminal should be matched or DEFAULT pin should be pulled Low to force the RPM2A baud rate to 9600bps.

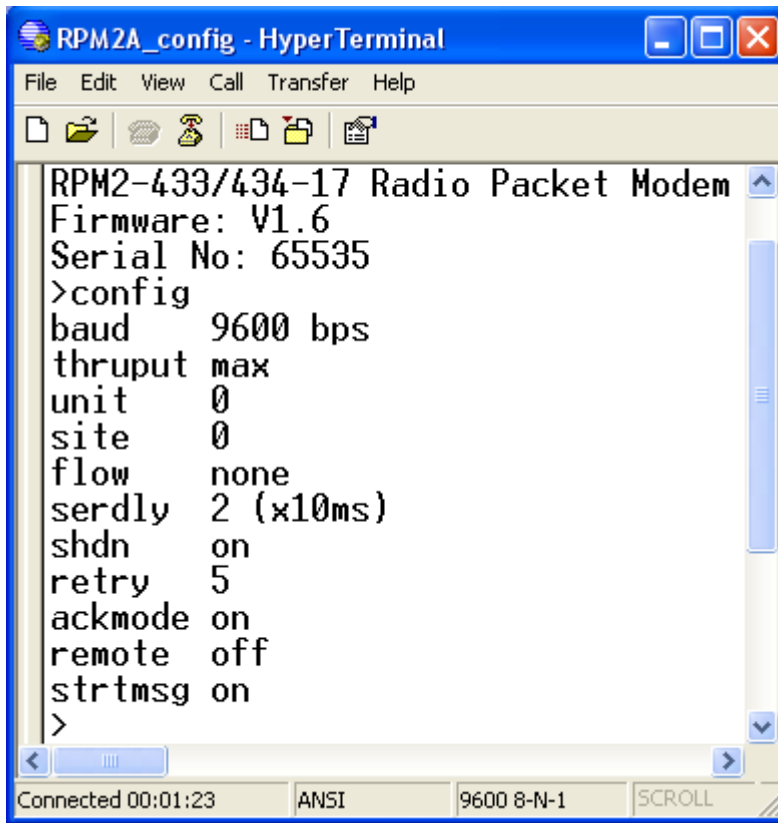

Figure 7: RPM2A configuration using HyperTerminal

User configurable parameters described in section 3.2 should be entered in the command prompt > followed by Carriage Return (CR) key. Then SETUP should be pulled-up to VCC and RPM2A should be RESET to exit the configurator and for the new parameters to be used by RPM2A.

4.0 EXTENDED RADIO PACKET MODEM FEATURES

4.1 THROUGHPUT

The RPM2A supports three rates, max (17kbps), slots (3.6kbps) and slotsw (1.8kbps), of over-air throughput.

MAX: When set to maximum and streaming data at the RPM2A, the data is sent as quick as possible. For host baud rates above 9600bps, data is transmitted continuously with minimal delay between sequential packets. When this occurs, there is effectively no airtime for another pair, operating in close proximity, to transmit without causing collisions. The maximum over-air throughput that can be achieved is 17kbps with ACK and 28kbps without ACK..

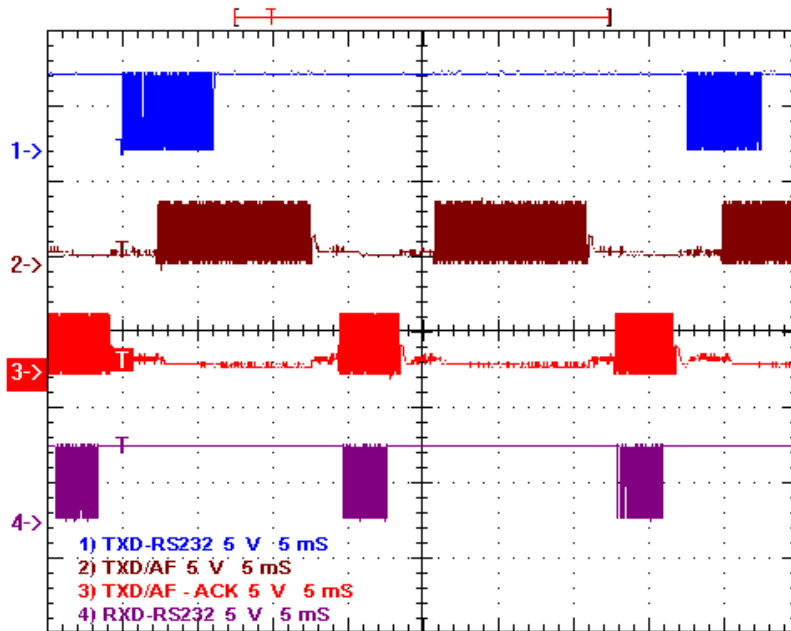

Figure 8: RPM2A streaming data with ACK at maximum throughput

In Figure 8, RS232 serial data bytes accumulated in the receive buffer is transmitted as two 10kbps bursts by transmitting RPM2A with gaps just enough to receive ACK from receiving RPM2A.

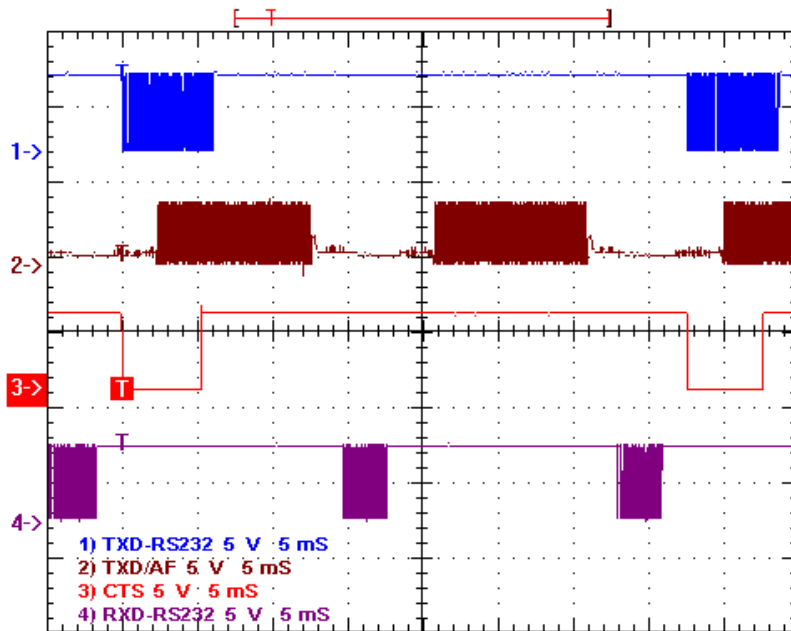

Figure 9: RPM2A streaming data without gap for another RPM2A pair

For continuous data transmission at baud rates above 9600bps (with ACK) or 19200bps (without ACK), hardware flow control should be used to prevent the host from causing receive buffer overrun errors. RPM2A will signal CTS pin to stop/allow the host depending on its Receiver Buffer level.

SLOTS: Setting the throughput to *SLOTS* provides a method of opening about 85ms 'time slots' for other RPM2A pairs operating in close proximity. The effective streaming on-air throughput between a pair of RPM2A is effectively reduced to approximately 3.6kbps (with/without ACK).

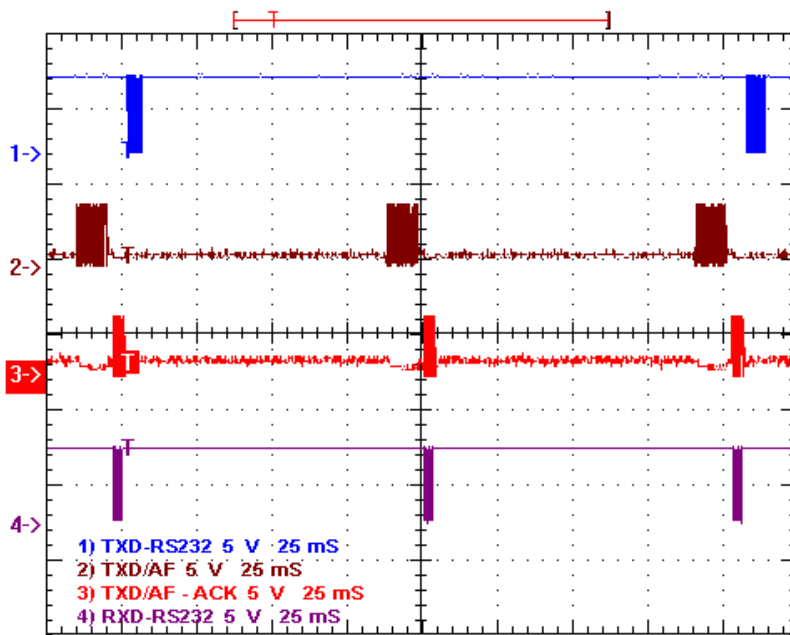

Figure 10: RPM2A operating in slots throughput mode with ACK for each transmission

SLOTSW: This setting effectively widens the *SLOTS* to about 185ms, reducing the over-air throughput to approximately 1.8kbps (with/without ACK). It allows more RPM2A pairs to share the same frequency. Host should obey CTS flow control signal from RPM2A when using *SLOTS* or *SLOTSW* mode.

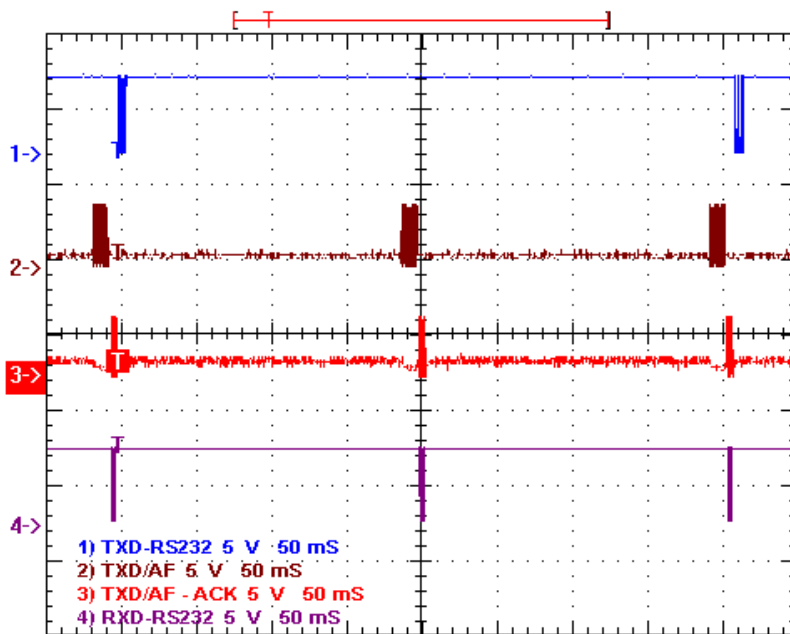

Figure 11: RPM2A operating in slotsw throughput mode

Overall throughput of the RPM2A is fixed according to thruput mode selected. Effective throughput will vary according to the file transfer protocol used. ZMODEM is the most popular and fastest protocol but it still adds its own header, CRC, link control bits to the data packet being transmitted reducing the actual throughput.

4.2 Remote Configuration

Remote configuration of a RPM2A module is possible using the *REMOTE* command from within the configurator. The remote RPM2A unit should be on or in auto-standby mode.

Initially the *REMOTE* command is used to enable and disable the ability to remotely configure a module, as described in section 3.2: User Configurable Command.

Once remote configuration is enabled the *REMOTE* command is then used to issue configuration commands to a remote RPM2A. The format for the remote command then becomes:

```
REMOTE <SERIAL NUM> <COMMAND> <PARAMTER>
```

The <SERIAL NUMBER> of the remote RPM2A must be known in order for the remote configuration request to be executed on the appropriate RPM2A module.

The <COMMAND> to be executed can be any of the following:

- Baud 600,1200,2400,4800,9600,19200,38400,57600,115200
- Unit 0 to 15
- Site 0 to 7
- Shdn on/off
- Flow hw/none
- Serdly 2 to 255
- Retry 1 to 63
- Strtmsg on/off

The <PARAMETER> is optional, and if not specified the setting for that command is returned and displayed.

4.3 POINT-TO-MULTIPOINT

The *RPM2A* can be used for point-to-multipoint communications. One module must be considered to be the master, which is used to address up to 15 remote units in any one site.

During normal operation, the base unit can be set to address another unit dynamically by entering the configurator and using the *ADDR* command to change the unit address. Upon execution of this command, provided the parameters are correct, the configurator is exited immediately. A period ('.') is sent to the connected host device to indicate that the change has been registered and the *RPM2A* is now ready for communications to the new unit address.

ADDR is very similar to the *Unit* command, except that *ADDR* does not update the stored EEPROM unit value. As the EEPROM has a limited number of write cycles, using *ADDR* for addressing multiple units in a point to multipoint network is recommended. Also, the *ADDR* command will exit the configurator immediately, which is required to resume communications very quickly.

4.4 BROADCAST MULTIDROP

The *RPM2A* has a broadcast mutidrop mode which provides a mechanism for building a large networks. This mode of operation is determined by the configuration command keyword ***ACKMODE*** being set to ***OFF***. In broadcast mutidrop mode, the *RPM2A* does not implement network layer functionality related to data packet routing, acknowledgement and retries. The connected host device should provide network layer functionality.

The site code and unit address is still used by the radio modem when working in broadcast multidrop mode. For a given multipoint network all radio modems within a group must contain the same site code and unit address.

4.5 RADAR: DIAGNOSTIC TEST

Built into the configurator is a diagnostic test suitable for range testing and link confidence testing. The Radar test effectively sends a small request packet to a remote unit then waits for a reply. The remote unit must not be in the configurator otherwise it will not respond.

Upon receipt of a positive response from the remote unit, a success is recorded before the process is repeated. This test will continue indefinitely until it is ended by a key press.

4.6 Radio Packet Modem Error Handling

The RPM2A's radio decoder module is deliberately non bit error tolerant, i.e. no attempt is made to repair corrupt data bits. All of the redundancy in the code is directed towards error checking. For an FM radio link using short packet lengths, packets are either 100% or so grossly corrupt as to be unrecoverable. By the same reasoning, the Host is not informed or sent corrupt data since corrupt information is of little value. The RPM2A implements packet acknowledges, timeouts and re-transmission to accomplish reliable error handling.

Ordering information

Part number	Supply	RF power	SMA Connector	SMA Antenna
European: 433.92MHz				
RPM2A				
RPM2A-433-17	5V	10mW		
RPM2A-433-17-3V	3V	10mW		
RPM2A-433-17-SMA	5V	10mW	Yes	
RPM2A-433-17-3V-SMA	3V	10mW	Yes	
RPM2A-433-17-ANT	5V	10mW	Yes	Yes
RPM2A-433-17-3V-ANT	3V	10mW	Yes	Yes
RPM2H				
RPM2H-433-17	5V	25mW		
RPM2H-433-17-3V	3V	25mW		
RPM2H-433-17-SMA	5V	25mW	Yes	
RPM2H-433-17-3V-SMA	3V	25mW	Yes	
RPM2H-433-17-ANT	5V	25mW	Yes	Yes
RPM2H-433-17-3V-ANT	3V	25mW	Yes	Yes
RPM2EH				
RPM2EH-433-17	5V	100mW		
RPM2EH-433-17-SMA	5V	100mW	Yes	
RPM2EH-433-17-ANT	5V	100mW	Yes	Yes

Notes:

1. Standard RPM2A module will be supplied with neither the connector nor antenna.
2. If an SMA (or Reverse Polarity SMA) connector or 1/4 wavelength wire antenna is soldered on the protruding PCB section for SMA connector, then the RF pin (2) should be cropped with side cutters for better RF performance.
3. If the RF output is going to be taken from the RF pin (2) to on-board antenna or connector on the host PCB (motherboard) via 50Ω microstrip, the protruding section of the RPM2A PCB can be cut along the width of the RPM2A to remove the redundant connector section.
4. RPM2A is supplied with 7mm long pins which need to be trimmed to mount the module as close as possible to the host PCB (motherboard). Ideally, the black coloured plastic spacer on the RPM2A pinheader should be touching (resting on) the host PCB.

Radiometrix Ltd

**Hartcran House
231 Kenton Lane
Harrow, Middlesex
HA3 8RP
ENGLAND**

Tel: +44 (0) 20 8909 9595

Fax: +44 (0) 20 8909 2233

sales@radiometrix.com

www.radiometrix.com

Copyright notice

This product data sheet is the original work and copyrighted property of Radiometrix Ltd. Reproduction in whole or in part must give clear acknowledgement to the copyright owner.

Limitation of liability

The information furnished by Radiometrix Ltd is believed to be accurate and reliable. Radiometrix Ltd reserves the right to make changes or improvements in the design, specification or manufacture of its subassembly products without notice. Radiometrix Ltd does not assume any liability arising from the application or use of any product or circuit described herein, nor for any infringements of patents or other rights of third parties which may result from the use of its products. This data sheet neither states nor implies warranty of any kind, including fitness for any particular application. These radio devices may be subject to radio interference and may not function as intended if interference is present. We do NOT recommend their use for life critical applications.

The Intrastat commodity code for all our modules is: 8542 6000

R&TTE Directive

After 7 April 2001 the manufacturer can only place finished product on the market under the provisions of the R&TTE Directive. Equipment within the scope of the R&TTE Directive may demonstrate compliance to the essential requirements specified in Article 3 of the Directive, as appropriate to the particular equipment.

Further details are available on The Office of Communications (Ofcom) web site:

<http://www.ofcom.org.uk/>

Information Requests

Ofcom

Riverside House

2a Southwark Bridge Road

London SE1 9HA

Tel: +44 (0)300 123 3333 or 020 7981 3040

Fax: +44 (0)20 7981 3333

information.requests@ofcom.org.uk

European Communications Office (ECO)

Peblingehus

Nansensgade 19

DK 1366 Copenhagen

Tel. +45 33896300

Fax +45 33896330

ero@ero.dk

www.ero.dk
