

Parani-SD100/200

User Guide

Version 1.1.7.1

2011-12-26

User Guide for the Parani-SD100/200

Version 1.1.7.1

Firmware version 1.1.X

Last revised on Dec. 26, 2011

Printed in Korea

Copyright

Copyright 2006~2012, Sena Technologies, Inc. All rights reserved.

Sena Technologies reserves the right to make changes and improvements to its product without providing notice.

Trademark

Parani™ is a trademark of Sena Technologies, Inc.

Windows® is a registered trademark of Microsoft Corporation.

Ethernet® is a registered trademark of XEROX Corporation.

Notice to Users

When a system failure may cause serious consequences, protecting life and property against such consequences with a backup system or safety device is essential. The user agrees that protection against consequences resulting from system failure is the user's responsibility.

This device is not approved for life-support or medical systems.

Changes or modifications to this device not explicitly approved by Sena Technologies will void the user's authority to operate this device.

Precautions and Safety

Electricity

Use only the supplied AC adapter. Use of unauthorized power adapter is not recommended. Electrical shock may result.

Do not kink or crease the power cable or place heavy objects on the power cable. Fire can result from damaged power cables.

Do not handle power plug and adapter with wet hands. Electrical shock may result.

Immediately power off the product and unplug the AC adapter if smoke or odors emit from the product and adapter. Fire can result from improper use.

Immediately power off the product and unplug the AC adapter if water or other liquids are present. Fire can result from improper use.

Product

Parani-SD meets the RS-232 standards. Do not wire with non-standard products. Damage to your products may result from improper use.

Do not drop or subject the device to impact. Damage to your products may result from improper use.

Keep away from harsh environments including humid, dusty, and smoky areas. Damage to your products may result from improper use.

Do not use excessive force on the buttons or attempt to disassemble the device. Damage to your products may result from improper use.

Do not place heavy objects on the product. Damage to your products may result from improper use.

Technical Support

Sena Technologies, Inc.

210 Yangjae-dong, Seocho-gu

Seoul 137-130, Korea

Tel: (+82-2) 576-7362

Fax: (+82-2) 573-7710

E-Mail: support@sena.com

Website: <http://www.sena.com>

Revision History

Revision	Date	Name	Description
V1.1.2	2007-05-26	Yh Moon	Initial Revision History
V1.1.3	2007-09-12	Yh Moon	Update Approval, Command Validity, 3.4 data bit, A.1 voltage, B3.7, remove at+dfu, S23, B3.4, ParaniWIN Dip switch conf.
V1.1.4	2007-01-07	Yh Moon	Firmware v1.1.3 update reflected
V1.1.5	2009-01-21	WJ Kim	Update dimension info.
V1.1.6	2009-03-10	Yh Moon	Update pairing button and add s43,44
V1.1.7	2009-06-01	WJ Kim	Modify package Info.
V1.1.7.1	2011-12-26	HR Zo	Package does not contain CD-ROM.

Contents

1. Introduction	7
1.1. Overview	7
1.2. Package Check List	7
1.2.1. Single Unit Package.....	7
1.2.2. Bulk-Pack Package.....	7
1.3. Product Specification.....	8
2. Getting Started	10
2.1. Panel Layout	10
2.2. Connecting the Hardware	11
2.2.1. Connecting Power to Parani-SD	11
2.2.2. Connecting Device to Parani-SD	12
2.2.3. Attaching Batter Pack to Parani-SD200.....	12
3. Configuration	13
3.1. Operation Modes.....	13
3.2. LED Indicators.....	13
3.3. Serial Ports	14
3.4 Data Bit.....	14
3.5 Hardware Flow Control	14
3.6 Reset to Factory Defaults.....	15
3.7 Dipswitch	15
3.8 Pairing Button.....	15
3.9 Software and Utility	17
3.10 ParaniWIN	17
3.11 ParaniUpdater	23
3.12 Terminal Program	23
4. Approval Information	25
4.1. FCC	25
4.1.1. FCC Compliance Statement	25
4.1.2. RF Exposure Statement.....	25
4.1.3. Do not.....	25
4.2. CE	25
4.2.1. EC-R&TTE Directive	25
4.3. MIC	25
4.4. Telec	25
4.5. SIG	25
5. RF Information	26
5.1. Radio Frequency Range	26
5.2. Number of Frequency Channel	26
5.3. Transmission Method	26
5.4. Modulation Method.....	26
5.5. Radio Output Power	26
5.6. Receiving Sensitivity	26
5.7. Power Supply	26
Appendix A: Connections	27
A.1. Serial Port Pin Outs	27
A.2. Serial Wiring Diagram	28
A.2.1. To Host with DTE Interface.....	28
A.2.2. To Host with DCE Interface	28
Appendix B: AT Commands	29
B.1. Terminology.....	29
B.1.1. AT Command	29
B.1.2. AT Response	29

B.1.3. Operation Mode.....	29
B.1.4. Operation Status.....	29
B.1.5. Security.....	29
B.1.6. Symbols.....	30
B.2. Command Category.....	30
B.3. Command Description.....	31
B.3.1. ATZ↵.....	31
B.3.2. AT&F↵.....	31
B.3.3. AT↵.....	31
B.3.4. AT+UARTCONFIG,Baudrate,Parity,Stopbit↵.....	31
B.3.5. AT+USEDIP?↵.....	32
B.3.6. AT+BTINFO?↵.....	32
B.3.7. AT+BTINQ?↵.....	32
B.3.8. AT+BTLAST?↵.....	32
B.3.9. AT+BTVER?↵.....	33
B.3.10. AT+BTMODE,n↵.....	33
B.3.11. +++↵.....	33
B.3.12. AT+SETESC,nn↵.....	33
B.3.13. ATO↵.....	34
B.3.14. AT+BTCANCEL↵.....	34
B.3.15. AT+BTSCAN↵.....	34
B.3.16. AT+BTSCAN,n,to↵.....	34
B.3.17. AT+BTSCAN112233445566,to↵.....	35
B.3.18. ATD↵.....	35
B.3.19. ATD112233445566↵.....	35
B.3.20. ATA↵.....	36
B.3.21. ATA112233445566↵.....	36
B.3.22. ATH↵.....	36
B.3.23. AT+BTKEY=\$string↵.....	36
B.3.24. AT+BTSD? ↵.....	37
B.3.25. AT+BTCSD↵.....	37
B.3.26. AT+BTFFP,n↵.....	37
B.3.27. AT+BTSEC,Authentication,Encryption↵.....	37
B.3.28. AT+BTNAME=\$string↵.....	38
B.3.29. AT+BTLPM,n↵.....	38
B.3.30. AT+BTRSSI,n↵.....	38
B.3.31. AT&V↵.....	39
B.3.32. AT\$nn? ↵.....	39
B.3.33. AT\$nn=mm↵.....	39
B.4. Command Validity.....	39
Appendix C: S-Register	41
C.1. S1: Force to Reconnect (default 1).....	41
C.2. S3: Stream UART Policy (default 0).....	41
C.3. S4: Enable Remote Name Query (default 1).....	41
C.4. S6: Enable Low Power Mode (default 0).....	41
C.5. S10: Enable Response Message (default 1).....	41
C.6. S11: Enable Escape (default 1).....	41
C.7. S12: Clear Data Buffer When Disconnected (default 0).....	42
C.8. S13: Enable DCD Signal (default 1).....	42
C.9. S14: Enable DTR Transfer (default 1).....	42
C.10. S15: Enable Disconnect by DTR (default 0).....	42
C.11. S22: Faster Connection (default 0).....	42
C.12. S23: Intercharacter Timeout Setting (default 0).....	42
C.13. S24: Maximum Number of Inquiry Result (default 10).....	42
C.14. S26: Intercharacter Timeout (default 0).....	42
C.15. S28: Escape Sequence Character (default 43).....	43

C.16. S31: Page Timeout (default 300).....	43
C.17. S33: Inquiry Timeout (default 30)	43
C.18. S37: Supervision Timeout (default 16000)	43
C.19. S43: COD (default 001F00).....	43
C.20. S44: COD Filter (default 000000).....	43
C.21. S45: IAC(Inquiry access code).....	43
C.22. S46: BD Address of Last Connected Device.....	43
C.23. S47: Select Low Power Mode (default 0).....	43
C.24. S48: Low Power Max Interval (default 2048)	44
C.25. S49: Low Power Min Interval (default 800)	44
C.26. S50: Low Power Sniff Attempt (default 8).....	44
C.27. S51: Low Power Sniff Timeout (default 8).....	44
C.28. S52: Low Power Park Timeout (default 5).....	44
Appendix D: Trouble Shooting	45
D.1. No Data Transmission	45
D.1.1. COM Port Settings	45
D.1.2. Pin Assignment.....	45
D.2. Data Loss or Malfunctioning	45
D.2.1. Hardware Flow Control.....	45
D.2.2. Response Message.....	45
D.3. Transmission Delay	45
D.3.1. RF Processing Delay.....	45
D.3.2. RF Transmission Environment.....	45
Appendix E: Parani-SD100/200 mechanical drawing	46
E.1. Parani-SD100 mechanical drawing	46
E.2. Parani-SD200 mechanical drawing	47
E.3. Parani-SD200 battery pack mechanical drawing.....	48
Appendix F: Warranty	49
F.1. GENERAL WARRANTY POLICY.....	49
F.2. LIMITATION OF LIABILITY	49
F.3. HARDWARE PRODUCT WARRANTY DETAILS	49
F.4. SOFTWARE PRODUCT WARRANTY DETAILS	50
F.5. THIRD-PARTY SOFTWARE PRODUCT WARRANTY DETAILS	50

1. Introduction

1.1. Overview

Parani-SD is a terminal device for wireless serial communication using Bluetooth technology that is an international standard of short range wireless communications. Parani-SD can communicate with other Bluetooth devices; user may connect other Bluetooth devices that support the Serial Port Profile.

Parani-SD provides several models with different communication ranges, from 30m (Parani-SD200) up to 100m (Parani-SD100) for various applications.

Parani-SD has a compact design, which allows it to be placed conveniently into various devices or equipment. Its detachable antenna has the ability to optimize the quality and distance of wireless communications.

Parani-SD supports FHSS (Frequency Hopping Spread Spectrum), which is a technique, native to Bluetooth that allows the Parani-SD minimize radio interference while decreasing the likelihood of over-air hijacking. Parani-SD also supports authentication and Bluetooth data encryption.

Parani-SD can be configured and controlled by a set of AT commands. Users can easily configure Parani-SD on a terminal program, such as HyperTerminal, and configure for wireless communication without modifying user's existing serial communication program. User friendly ParaniWIN can also be used for easy setup on Microsoft Windows.

1.2. Package Check List

1.2.1. Single Unit Package

SD100-A1 / SD200-A1 (Stub antenna NOT included)

- Parani-SD100/200

SD100-00 / SD200-00

- Parani-SD100/200
- Stub Antenna
- DC 5V Power Cable
- USB Power Cable
- DB9 Female to DB9 Male Gender
- A hardcopy of Quick Start Guide

SD100-01 / SD200-01

- Parani-SD100/200
- Stub Antenna
- DC 5V Power Cable
- USB Power Cable
- DC Power Adapter
- DB9 Female to DB9 Male Gender
- A hardcopy of Quick Start Guide

1.2.2. Bulk-Pack Package

SD100-B10 / SD200-B10

- Parani-SD100/200 (x10EA)
- Stub Antenna (x10EA)
- DC 5V Power Cable (x10EA)

1.3. Product Specification

	Parani-SD100	Parani-SD200
Serial Interface	One female DB9 serial port for data communication Serial speeds 1200bps to 230400bps Flow Control: None, Hardware (RTS/CTS) Signals: Rx, Tx, RTS, CTS, DTR, DSR, GND, DCD	
Bluetooth Interface	Bluetooth v1.2 * Protocol: RFCOMM, L2CAP, SDP Profile: Serial Port Profile	
	Class 1	Class 2
	Level: 18dBm	Level: Max. 4dBm
	Working distance: Default-Default Antenna 100m Default-Dipole Antenna 150m Dipole-Dipole Antenna 200m Patch-Dipole Antenna 400m Patch-Patch Antenna 1000m	Working distance: Default-Default Antenna 30m Default-Dipole Antenna 50m Dipole-Dipole Antenna 80m Patch-Dipole Antenna 150m Patch-Patch Antenna 300m
Configuration	ParaniWIN, Modem AT command set	
Firmware Update	ParaniUpdater	
Diagnostic LED	Power Standby Connect Serial Rx/Tx	
Power	Supply voltage: 5V ~ 12V DC Supply current - Parani-SD100 : minimum 300mA - Parani-SD200 : minimum 150mA Nominal power consumption - Parani-SD100 : 60mA@9600bps, 81mA@115Kbps - Parani-SD200 : 58mA@9600bps, 66mA@115Kbps	
	Common Power supply options: Power via a standard AC-plug DC-adapter Power via USB power cable Power via DC power cable Power via pin 9 of DB9 connector Battery Pack for Parani-SD200 only	
Battery Usage Time	When using battery pack for Parani-SD200 - Typical 1.5V –AA alkaline batteries (2500mAh) Avg. 11hr@9600bps Note : Depending on the batteries and its usage environment greatly determines how long the Parani product will last for their application, i.e. battery storage, battery capacity, battery brand and so on.	
Environmental	Operating temperature: -10 ~ 55 °C Storage temperature: -20 ~ 70 °C Humidity : 90% (Non-condensing)	

Physical properties	Dimension 70 mm L 30.8 mm W 16.2 mm H	Dimension 75.3 mm L 30.8 mm W 16.2 mm H
	Weight 22 g	Weight 20 g
Approvals	FCC(A), CE(A), MIC, Telec, SIG	
Warranty	3-year limited warranty	



Note * :

Bluetooth v1.2 supports improved AFH function. AFH function is to mitigate the interference between WiFi and Bluetooth radios by automatically avoiding the active WiFi channel from Bluetooth link. However, AFH does not provide a complete solution making WiFi and Bluetooth work together in harmony. It is highly recommended for users to test their wireless system enough before deployment since the overall system performance is affected by various environmental factors such as distance between them.

2. Getting Started

This chapter describes how to set up the Parani-SD Series for the first time.

- 2.1 *Panel Layout* explains the panel layout.
- 2.2 *Connecting the Hardware* describes how to connect the power, the serial device, and the battery pack (for Parani-SD200 only) to the Parani-SD Series.

Following items are required to get started:

- One DC power adapter, USB power cable or DC power cable (included in the package).
- One PC with RS232 serial port.
- Terminal emulation program running on the PC
- One battery pack and two 'AA' batteries (optional accessory for Parani-SD200 only)

2.1. Panel Layout

This section describes the panel layout of the Parani-SD.

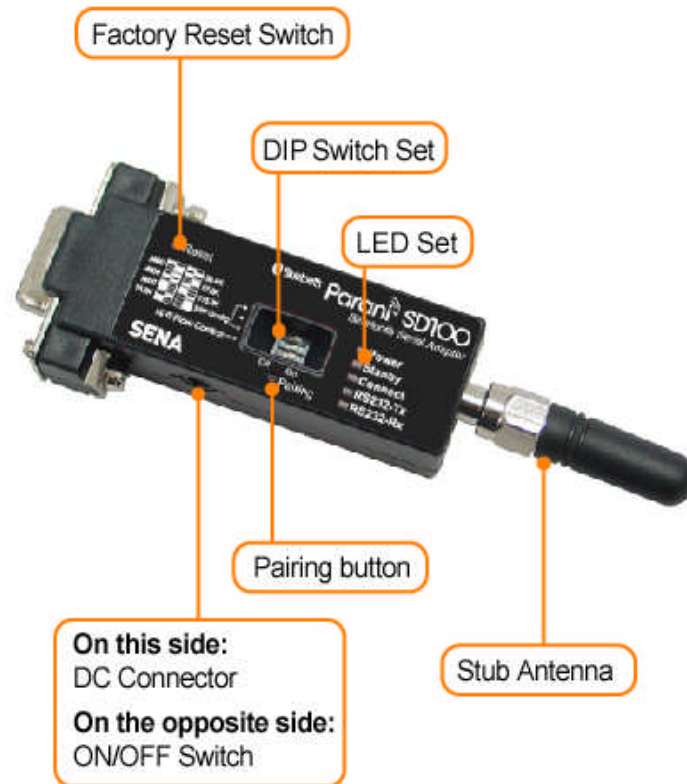

Figure **Error! Style not defined.**-1 The panel layout of Parani-SD100

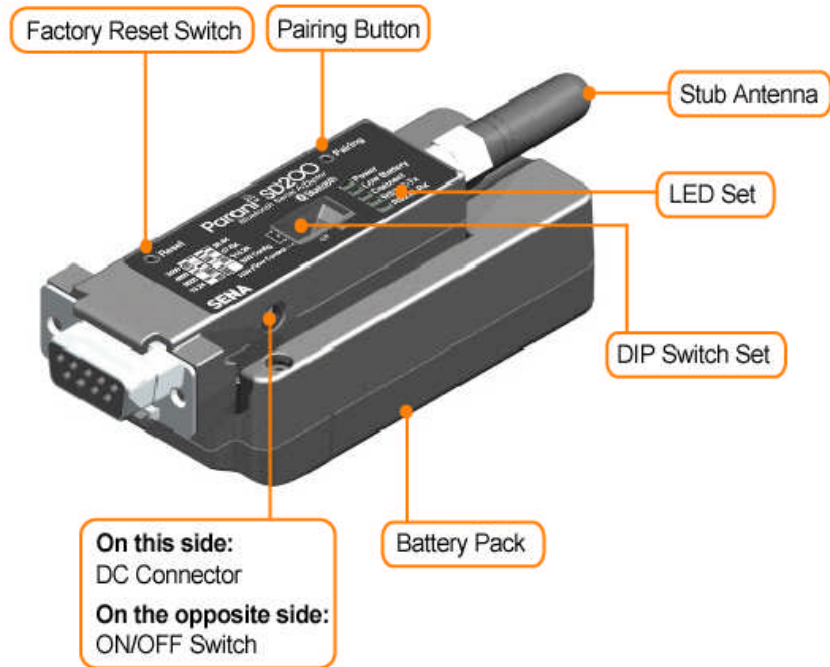

Figure **Error! Style not defined.**-2 The panel layout of Parani-SD200

2.2. Connecting the Hardware

This section describes how to connect the Parani-SD Series to the serial device.

- Connect a power source to the Parani-SD Series.
- Connect the Parani-SD Series to a serial device.

2.2.1. Connecting Power to Parani-SD

Connect the power jack to the power connector of the Parani-SD Series using the DC power adapter, USB power cable or DC power cable that is included in the package. If power is properly supplied, the [Power] lamp will display a solid green color.

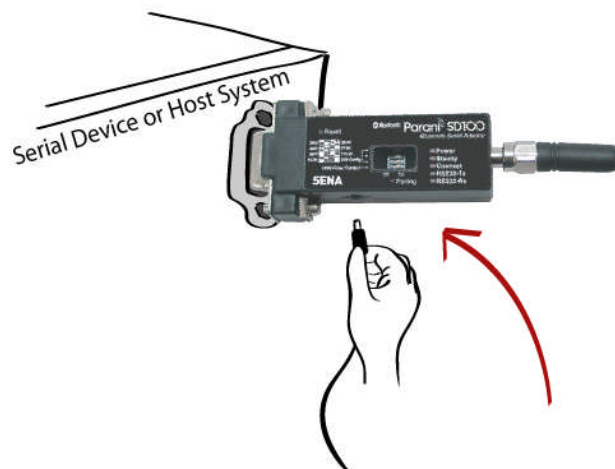

Figure **Error! Style not defined.**-3 Connecting Power to Parani-SD200

2.2.2. Connecting Device to Parani-SD

Connect the serial device to the Parani-SD Series as shown below.

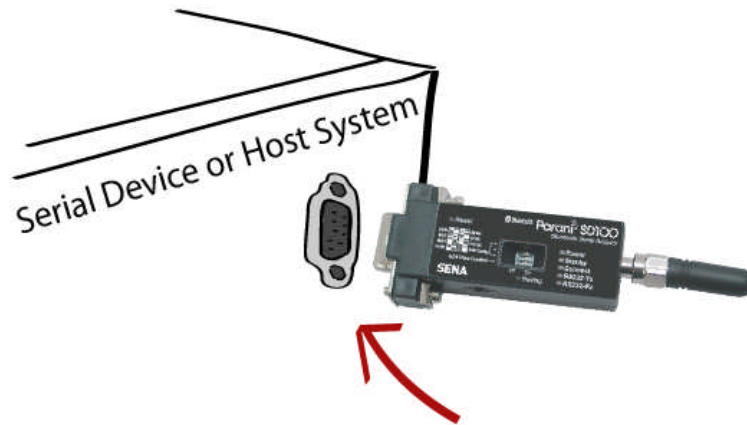

Figure *Error! Style not defined.*-4 Connecting a Serial Device to Parani-SD

2.2.3. Attaching Batter Pack to Parani-SD200

The Parani-SD200 supports a battery pack that can carry two AA batteries as an optional accessory. Users can use either standard or rechargeable batteries. (If rechargeable batteries are used, a separate charger will be needed to charge the batteries.)

Attach the battery pack to the Parani-SD200 as shown below.



Figure *Error! Style not defined.*-5 Attaching Batter Pack to Parani-SD200

3. Configuration

3.1. Operation Modes

In addition to the serial port configurations, the Parani-SD also requires includes some settings for Bluetooth. For getting the most out of Parani-SD, user should understand the following Bluetooth connection schemes.

A Bluetooth device can play a role as a master or slave. Master tries to connect itself to other Bluetooth devices, and slave is waiting to be connected from other Bluetooth devices. A Bluetooth connection is always made by a pair of master and slave devices. A slave can be in two modes, Inquiry Scan or Page Scan mode. Inquiry Scan mode is waiting for a packet of inquiry from other Bluetooth device and Page Scan mode is waiting for a packet of connection from other Bluetooth device. Every Bluetooth device has its unique address, called BD (Bluetooth Device) address, which is composed of 12 hexa-decimal numbers.

Parani-SD has 4 operation modes as follows. Each mode can be identified with LED indicators as illustrated in next section.







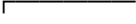



Table 3-1 The Parani-SD Operation Modes

Mode	Description
Mode0	<p>In this mode, there is no response when power on or software reset, and Parani-SD is just waiting for AT command input. Neither master nor slave is assigned to Parani-SD in mode0. User can change the configuration parameters of Parani-SD in this mode.</p> <p>Parani-SD must be in Mode0, when it is directly controlled by AT commands.</p> <p>The factory default is set to Mode0.</p>
Mode1	<p>Parani-SD tries to connect the last connected Bluetooth device.</p> <p>Parani-SD in Mode1 is to be a master and tries to connect the last connected Bluetooth device. Parani-SD always stores the BD address of the Bluetooth device to which Parani-SD has connected last. When Parani-SD is initially used or after hardware reset, there is no BD address stored in Parani-SD. In this case, Mode1 will not be able to work properly. The mode change to Mode1 can be made after Parani-SD succeeds to connect to one other Bluetooth device. Once changed to Mode1, Parani-SD will try to connect automatically the last connected Bluetooth device whenever the unit is powered on or software reset.</p> <p>Parani-SD in Mode1 cannot be discovered or connected by other Bluetooth devices.</p>
Mode2	<p>Parani-SD is waits for a connection from the last connected Bluetooth device.</p> <p>Parani-SD in Mode2 is to be a slave and waiting for the connection only from the last connected Bluetooth device. Just like Mode1, if there is no BD address stored in Parani-SD, the mode change from other operation modes to Mode2 is not work properly. Once changed to Mode2, Parani-SD will wait for the connection from the last connected Bluetooth device whenever the unit is powered on or software reset.</p> <p>Parani-SD in Mode2 cannot be discovered or connected to Bluetooth devices other than the last connected device.</p>
Mode3	<p>Parani-SD is waiting for the connection from any other Bluetooth devices. In Mode 3 the Parani-SD is discoverable and can be connected to by other Bluetooth devices.</p>

3.2. LED Indicators

RS232-Tx and RS232-Rx LED will flash accordingly when data is transmitted. For small data transmissions, it may be hard to recognize the quick flashing action of the LED.

Table 3-2 The Parani-SD LED Indicators

Indicator	Power LED	Standby LED	Connect LED
Mode0	Green 	Red 	
Mode1	Green 		Green (every 1 sec) 
Mode2	Green 		Green (every 3 sec) 
Mode3	Green 		Green (every 3 sec) 
Connected	Green 		Green 

3.3. Serial Ports

The applicable settings for serial ports are as follows.

Table 3-3 The Parani-SD Serial Port Settings

Serial Port Settings	Values
Baud rate	1200, 2400, 4800, 9600 , 19200, 38200, 57600, 115200, 230400
Data bite	8
Parity	No parity , Even parity, Odd parity
Stop bit	1 , 2
Hardware Flow Control	Use, No Use

The values in box are the factory defaults. The flow control setting is configurable only through dip switch.

3.4 Data Bit

Parani-SD supports only 8 data bit. In the case of 7 data bit and even/odd parity, use SD 8 data bit and none parity. At this time, master and slave are Parani-SD, Parani-ESD or Parani-MSP series. But 7 data bit and none parity is not support.

3.5 Hardware Flow Control

Parani-SD plugged into its host system transmits data from host to the other side Bluetooth device. This data is saved temporarily in the internal buffer of Parani-SD and sent repeatedly until the transmission is completed packet by packet. When the radio transmission condition is not good enough to send data promptly, it can cause a transmission delay. If the host sends more data when the buffer is full, buffer overflow will make Parani-SD malfunction consequently. In order to prevent this buffer overflow, Parani-SD works as follows.

When using hardware flow control, Parani-SD disables RTS so that it stops receiving any further data from the host when the buffer becomes full. RTS will be re-enabled again to begin receiving data from the host when the buffer has created more room for more data.

When hardware flow control is not being used, the Parani-SD clears the buffer to secure room for the next data when the buffer becomes full. This can mean a loss of data may occur. As the transmission data becomes large, the possibility of data loss becomes greater.

For large data transmissions, the use of hardware flow control is highly recommended.

3.6 Reset to Factory Defaults

To set all the configuration settings to its factory default parameters, press the reset button, depicted in Fig. 1-3. Press and hold (for at least 1 sec) the reset button with a narrow pointed tool like paper clip. Reset works only when power is on.

3.7 Dipswitch

With the combination of 4 slot dipswitches, baud rate and hardware flow control can be set.

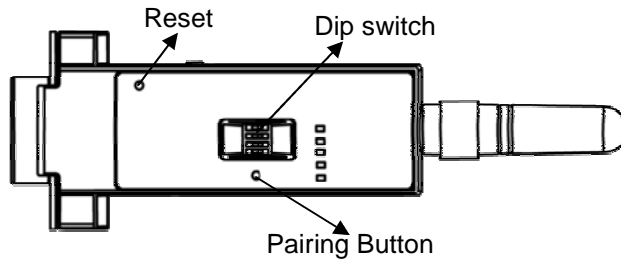

Figure 3-1 The Parani-SD Dipswitch

Upper 3 dipswitches are used for setting the baud rate, and bottom dipswitch is used for setting hardware flow control option. If the baud rate needs to a baud rate not shown below, ParaniWIN or terminal program should be used to set these speeds. To set a baud rate not shown below the dipswitches should be in the S/W Config setting. When in the S/W Config setting the baud rate will go back to 9600 as default.

Table 3-4 Baud rate Settings by Dipswitches

Baud rate	2400	4800	9600	19.2K	38.4K	57.6K	115.2K	S/W Config

Table 3-5 Hardware Flow Control Settings by Dipswitches

Hardware Flow Control Handshaking	No Use	Use

* Note: You cannot set the Parani-SD to a Baud rate of 1200 and 230K by way of the Dipswitch. If you want to use them, to set these speeds, please configure the dipswitch to S/W Config setting and use ParaniWIN or AT commands. Please refer to ParaniWIN and Appendix B.3.4 AT+UARTCONFIG, Baudrate, Paraty, Stopbit.

3.8 Pairing Button

Parani-SD provides Pairing Button for instant configuration without a PC to make an automatic connection between two Parani-SDs. In this example we will refer to the two Parani-SDs as SD1 and SD2, respectively. In pairing status, SD changes COD value automatically. (reference S43, S44)

Step 1. Turn on SD1 and SD2 and reset both of them by pressing Reset Button.

Step 2. Press the Pairing Button of SD1 for 2 seconds until Standby LED turns off and Connect LED

blinks 3 times every 2 seconds. Keep the power ON.

Step 3. Press the Pairing Button of SD2 for 2 seconds until Standby LED turns off and Connect LED blinks 3 times every 2 seconds. Now press again the Pairing Button for 2 seconds until Connect LED blinks every 0.5 second.

Step 4. Wait for SD1 & SD2 to connect to each other until the Connect LED of SD1 and SD2 are fully solid green. It takes about 10 seconds to make a connection. If there are many Bluetooth devices nearby, it may take longer.

Step 5. Turn SD1 off and on. Connect LED blinks twice in green every 3 seconds.

Step 6. Turn SD2 off and on. Connect LED blinks once in green every 1 second.

Step 7. Now SD1 and SD2 are configured to make automatic connection to each other, whenever they are powered on. Using a pair of Parani-SD in this fashion is similar to that of using a wireless serial cable.

* Note: When using the pairing buttons, the Command Response option will be deactivated automatically. The Parani-SD will not send the response messages such as OK, Connect and Disconnect.

Table 3-6 Pairing Process by Pairing Button

SD1	Status	LED	SD2	Status	LED
1. Hard reset	Mode0	Standby LED turns on	1. Hard reset	Mode0	Standby LED turns on
2. Push pairing button	Mode3	Connect LED blinks 3 times every 2 seconds	2. Push pairing button	Mode3	Connect LED blinks 2 times every 2 seconds
			3. Push pairing button again	Mode1	Connect LED blinks every 0.5 seconds
4. Connected	Slave	Connect LED is lit in green	4. Connected	Master	Connect LED is lit in green

Using pairing button, users can make a pairing connection between a Parani-SD Series unit and other Bluetooth devices.

Step 1. Turn on Parani-SD and reset it by pressing Reset Button.

Step 2. Press the Pairing Button of Parani-SD for 2 seconds until Standby LED turns off and Connect LED blinks 3 times every 2 seconds. Keep the power ON.

Step 3. Users can discover and connect to Parani-SD by using the software or user interface of other Bluetooth device that they want to connect from.

Step 4. When they are connected, the Connect LED of Parani-SD is changed into fully solid green.

Step 5. Turn off and on. Connect LED blinks twice in green every 3 seconds.

Step 6. Now Parani-SD is waiting for a connection from the last connected Bluetooth device. The last connected Bluetooth device can connect to Parani-SD.

Table 3-7 Pairing Process with other Bluetooth device by Pairing Button

Parani-SD	Status	LED	Other Bluetooth Device	Status
1. Hard reset	Mode0	Standby LED turns on		
2. Push pairing button	Mode3	Connect LED blinks 3 times every 2 seconds		
			3. Detect and connect to Parani-SD	
4. Connected	Slave	Connect LED is lit in green	4. Connected	Master

3.9 Software and Utility

This configuration software and utility for firmware update is included with the product, which also can be downloaded from <http://www.sena.com>

Table 3-8 Configuration Software

Software	Purpose	Operating System
ParaniWIN	Configuration	MS Windows 98SE or Higher
ParaniUpdater	Firmware Update	MS Windows 98SE or Higher

3.10 ParaniWIN

ParaniWIN is a program that runs on Microsoft Windows for the configuration of Parani-SD. Install ParaniWIN on your computer. Plug a Parani-SD into the serial port of the computer and turn on the power. Run ParaniWIN.

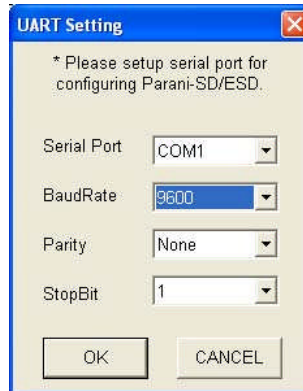

Figure 3-2 Serial Port Setting

Set each option properly and click [Confirm]. If the settings of the Parani-SD are different from the ParaniWin, an error message will pop up. If the Parani-SD is in the status of connection, warning message will pop up. Then the current connection can be cancelled by [Disconnect] button on the main window.

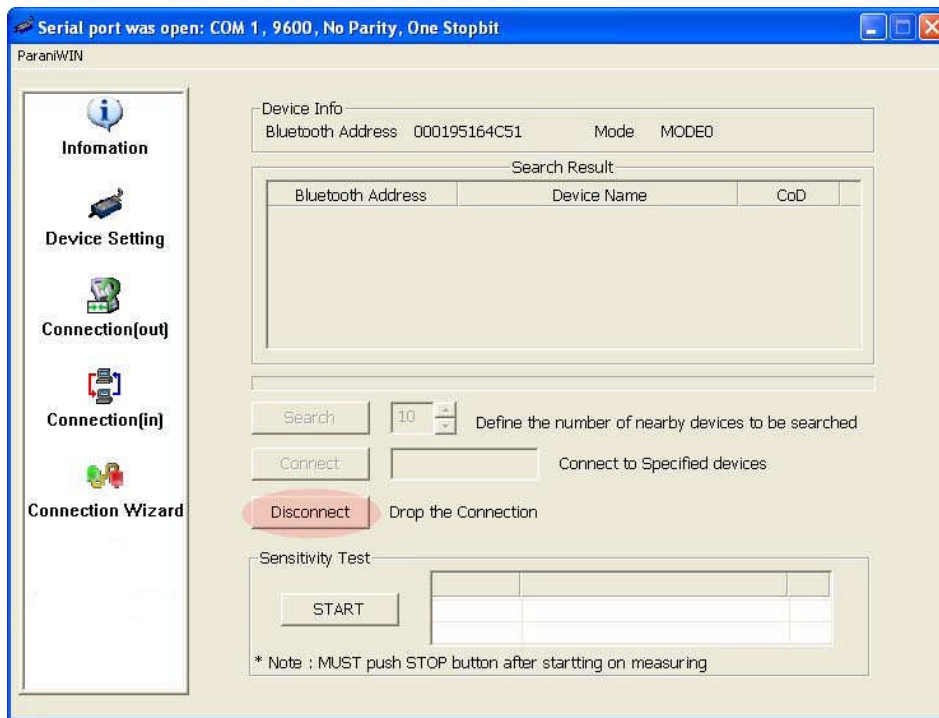

Figure 3-3 Main Window

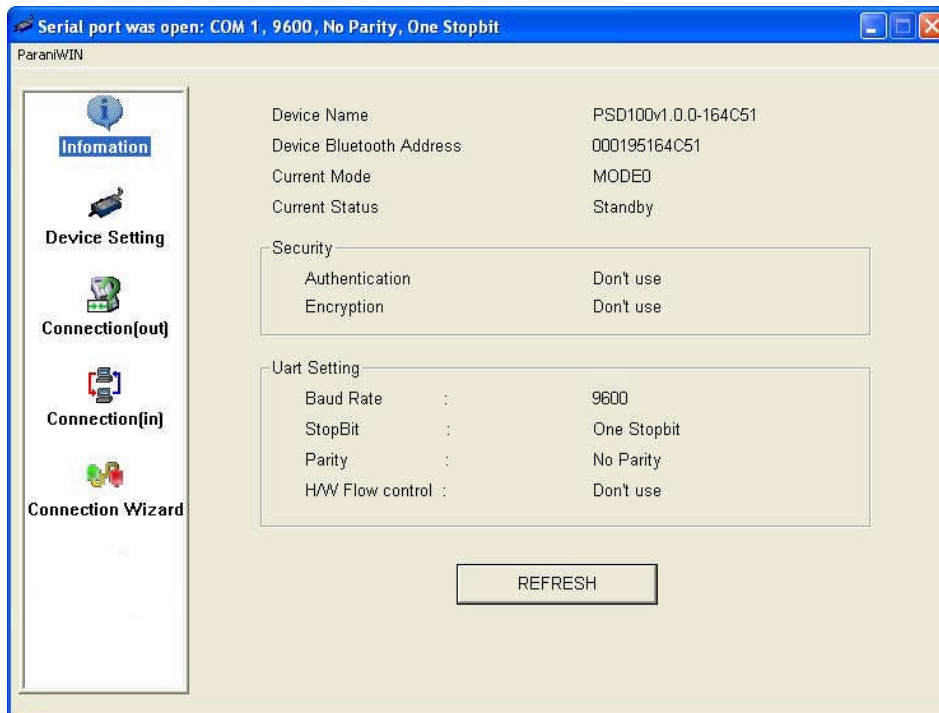

Figure 3-4 Information Window

Serial port settings can be changed by <Start Configuration> and <ParaniWIN Configuration> of ParaniWIN in the menu bar at upper left corner of the window without re-running the ParaniWIN program.

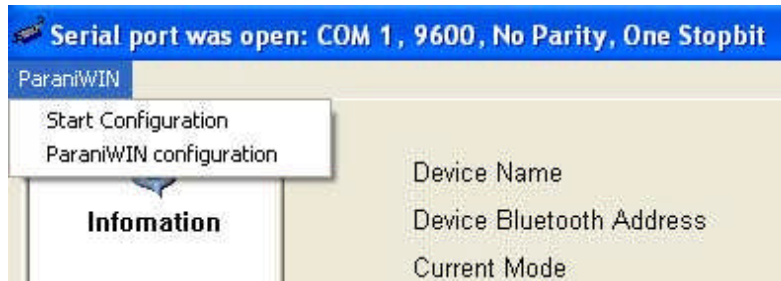

Figure 3-5 Menu Bar at Upper Left corner of ParaniWIN

When the ParaniWin software is able to access the Parani-SD properly, the icons in the left side window come will become available for use.

In device configuration window, hardware reset can be executed or operation mode and RS232 can be configured as well. Security option also can be configured in this window.

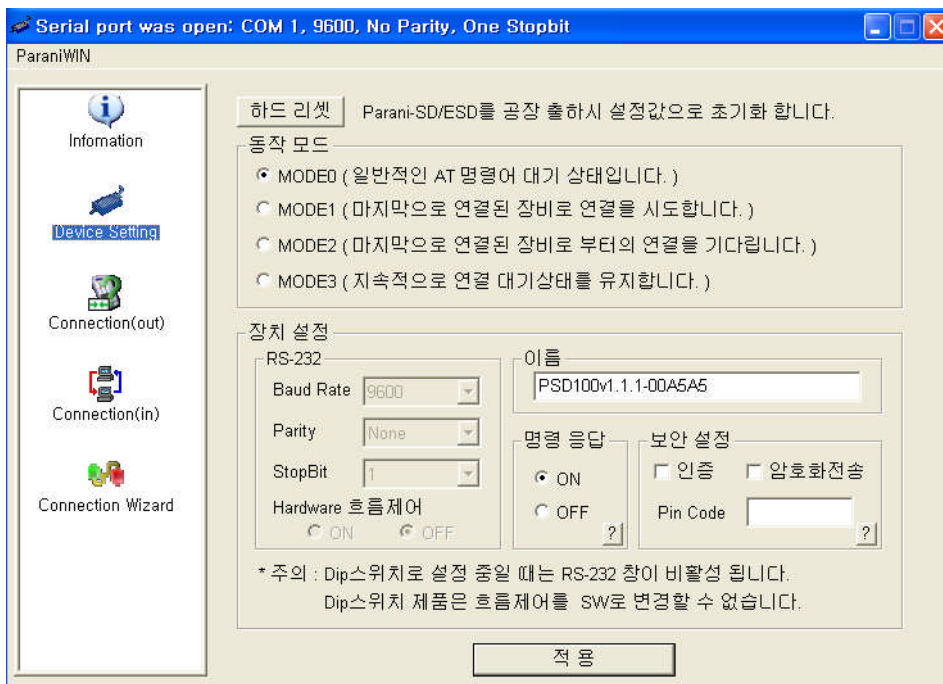

Figure 3-6 Device Setting Window

Parani-SD supports two security options, Authentication and Encryption. If you enable the Authentication option, you must also enter a Pin Code value. If the authentication is enabled, the connection, between the Master and Slave device must share the same Pin Code. In case that Parani-

SD connects to another Bluetooth device, that requires authentication, you must know the other device's Pin Code. In general, most Bluetooth devices have a pincode of 1234 or 0000. If you check Encryption option, the Parani-SD will encrypt packets and sent to the device. The Encryption options works well in case that only one of the devices between Master and Slave use the Encryption option.

Parani-SD has 4 response messages, 'OK', 'ERROR', 'CONNECT', and 'DISCONNECT'. In some cases, these responses can affect the host system unexpectedly. To prevent this, user can set the Command response to ON or OFF.

For Parani-SD100/200, hardware flow control can be configured only by dip switch. And parity, stop bit can be configured only SW config mode. Thus H/W Flow Control option will not work in this case. When the dipswitch value isn't ATcommand mode, the Baud Rate menu will be disabled.

Click [Apply] button to apply any changes made to the Parani-SD.

Connection(out) icon will show the following window to search and connect other Bluetooth devices.

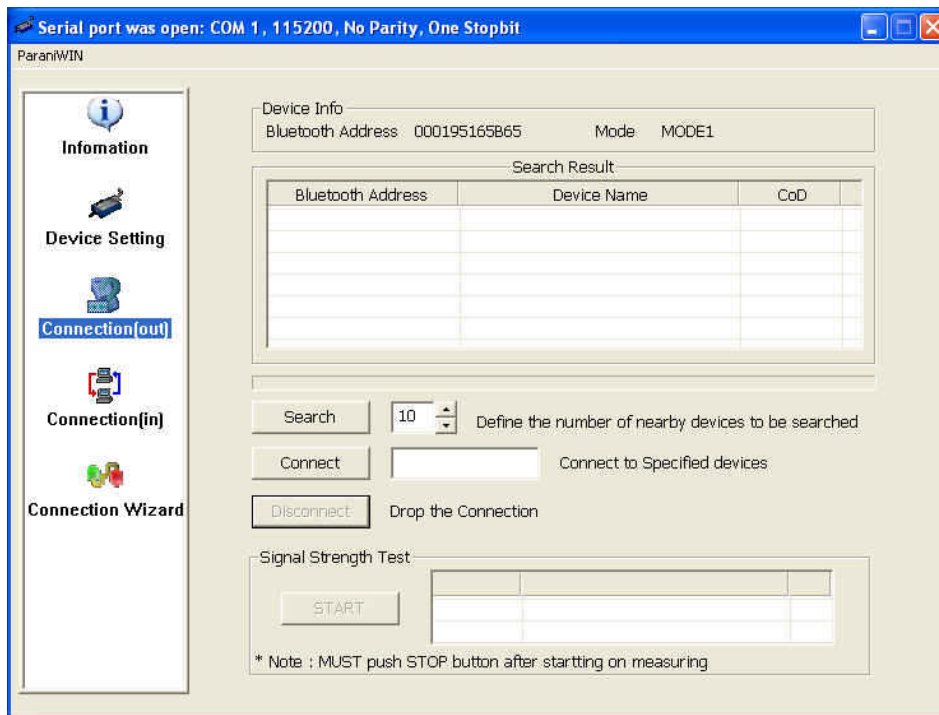

Figure 3-7 Connection(out) Window

Click [Search] button to search nearby Bluetooth devices. Once several Bluetooth devices has been found, select one of the devices and click the [Connect] button. The selected Bluetooth device must be discoverable and connectable. Click [Disconnect] button to cancel the connection.

After the connection has been established, you will be able to test signal strength by pushing the START button.

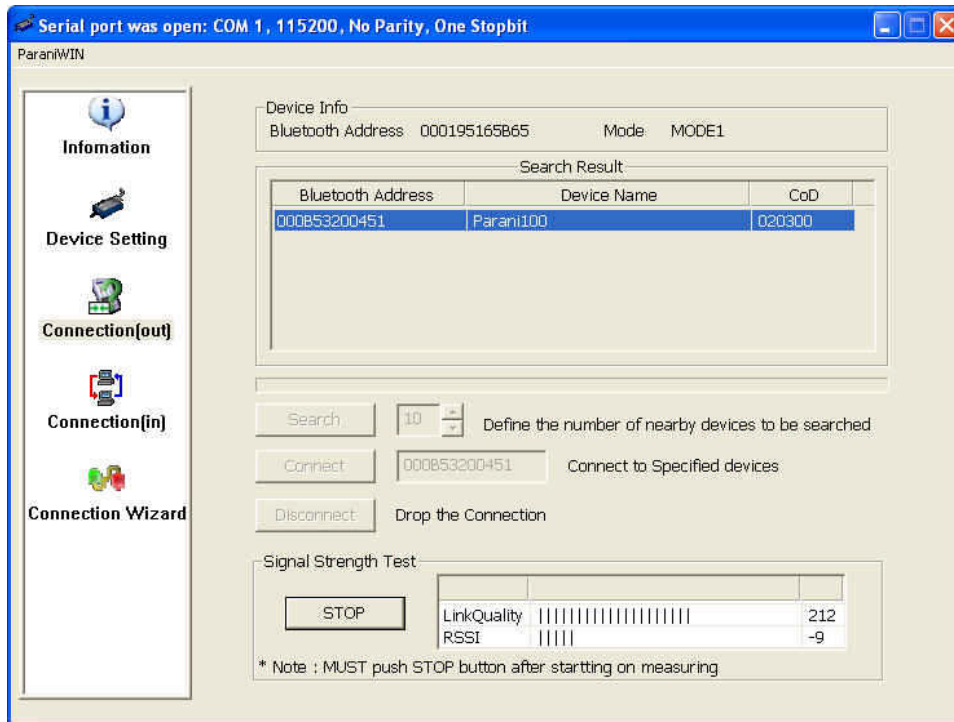

Figure 3-8 Signal Strength Test

The signal strength test shows LinkQuality and RSSI values. The closer LinkQuality is to 255 and RSSI is to 0, this means the Parani-SD has a good connection to the connected Bluetooth device. In general, the wireless connectivity is at its best within 10 meters. You can push the STOP button at anytime in order to terminate the signal strength test. The signal strength test will continue until the STOP button is pushed. If you close the ParaniWIN Window without pushing the STOP button, you must restart Parani-SD to terminate the test.

Connection(in) icon will show the following window, which enables the Parani-SD to wait for a connection from another Bluetooth device. If the waiting time is set to 0, Parani-SD will continually wait for connection until [Cancel] button is clicked.

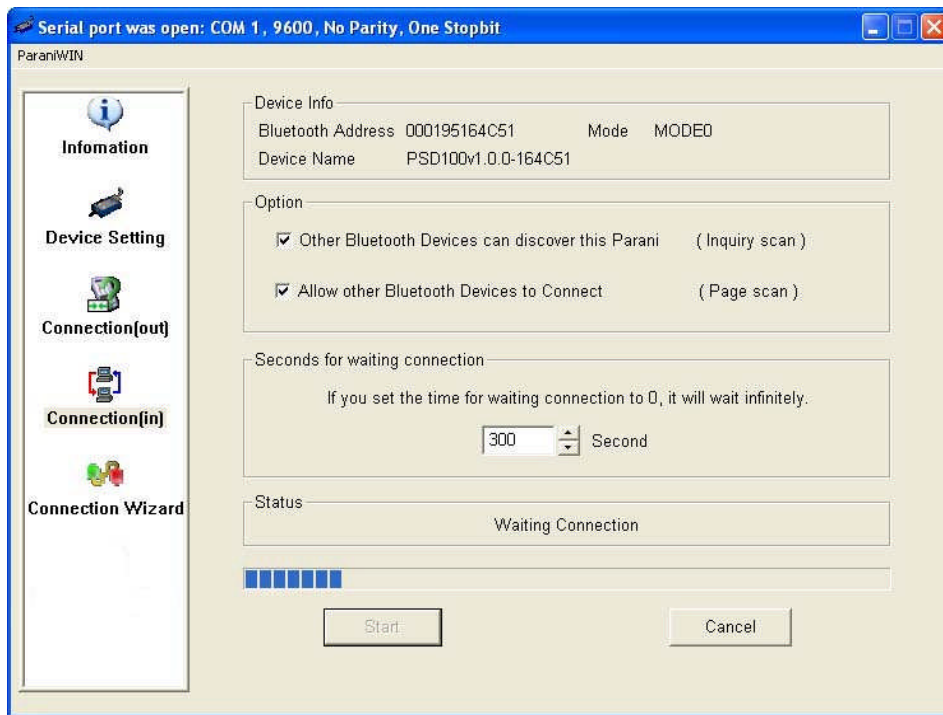

Figure 3-9 Connection(in) Window

If the Connection Wizard icon is clicked, an easy to use pairing menu will appear:

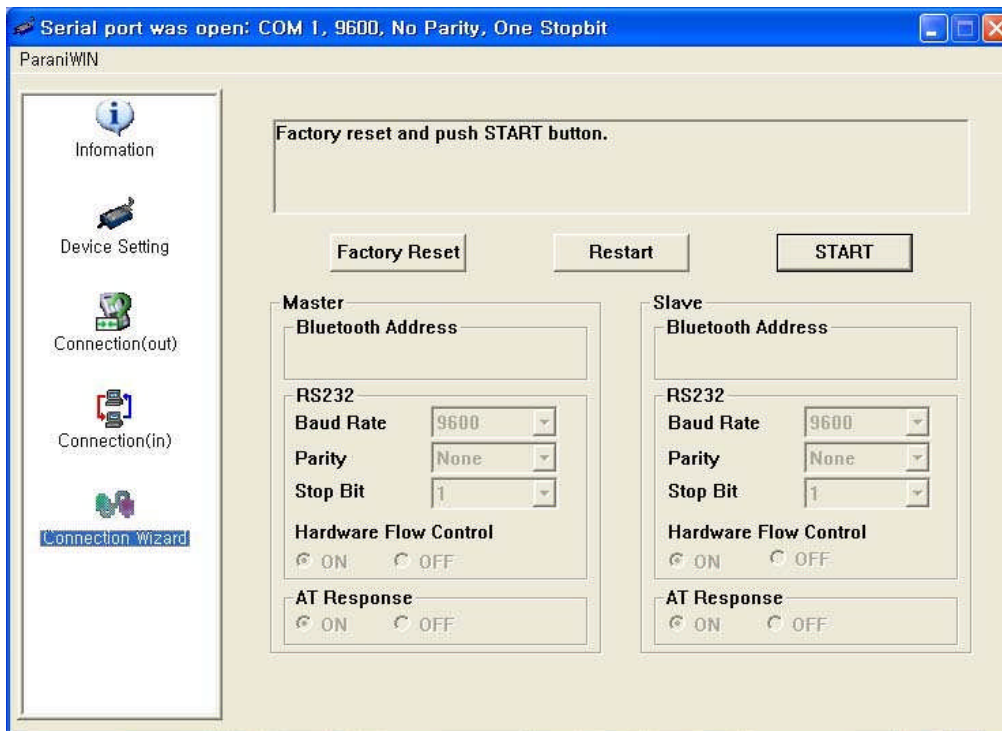

Figure 3-10 Connection Wizard Window

In this example we will refer to the two Parani-SDs as SD1 and SD2 respectively. To use this menu, please do the following:

Step 1. Connect SD1 and then push the START button.

Step 2. Disconnect SD1, connect SD2 and then push the Next button after setting up Slave configuration. At this time, the dip switch value should be ATcmd mode. The flow control setting can be changed only through dip switch.

Step 3. Disconnect SD2, once again connect SD1 and then push the Finish button. The pairing configuration should be completed. Make sure that each Parani-SD's connect LED is on. At this point, when both Parani-SD's restart the connection will be established automatically.

3.11 ParaniUpdater

Parani-SD supports firmware updates. You can download new firmware images for the Parani-SD at <http://www.sena.com>. With the ParaniUpdater, you can update the firmware of Parani-SD by selecting the firmware image file and pushing Start button.

* Note: DO NOT power off Parani-SD while the firmware update is progressing, this may damage the Parani-SD.

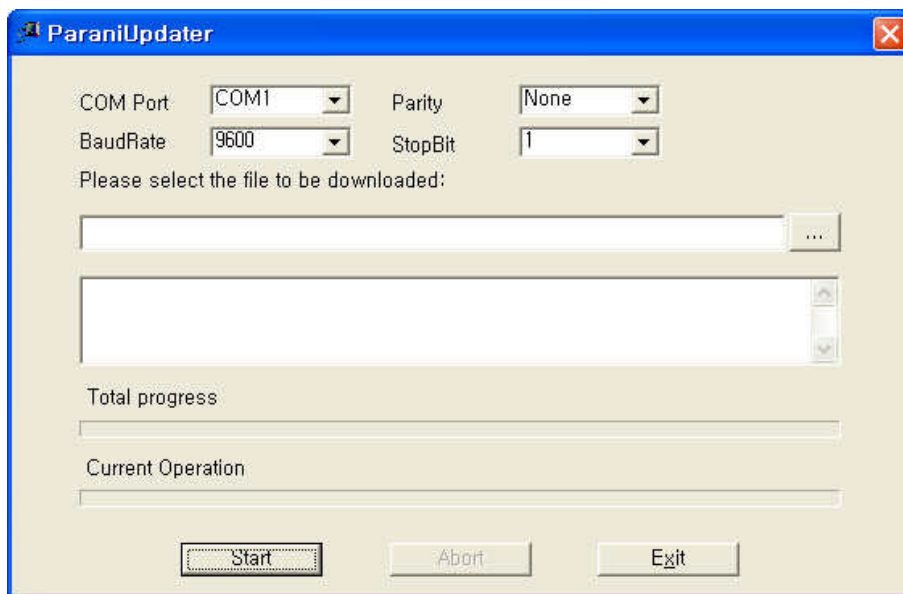

Figure 3-11 ParaniUpdater Window

3.12 Terminal Program

A terminal program is typically an application that will enable a PC to communicate directly with a modem. If you are using Windows 98SE or higher version of Windows, HyperTerminal program is included as part of the operating system. Parani-SD provides some extended AT commands for configuration of the Parani-SD.

This manual will explain the method using HyperTerminal. If you need to install HyperTerminal, click start>setting>control panel>add/remove programs. For more precise details on HyperTerminal installations, please refer to Microsoft Windows Help section..

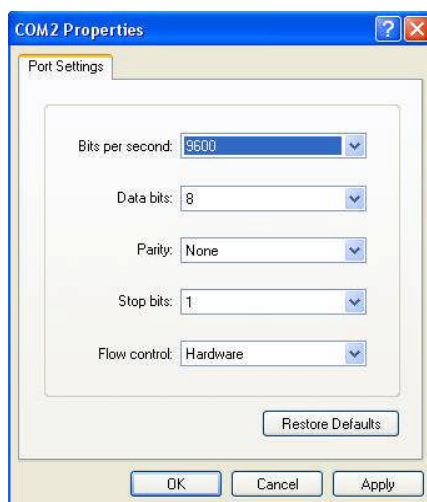

Figure 3-12 HyperTerminal

Attach Parani-SD to serial port of host computer and power on the Parani-SD. Check Connect LED and Standby LED

Their status may be as follows:

Table 3-9 Connect LED and Standby LED status

Connect LED	Standby LED	Meanings
On	Off	Connected to somewhere
Blinking	Off	Connecting to somewhere or waiting for incoming connection.
Off	On	Waiting for AT commands.

Make sure that the Connect LED is turned off and the Stanby LED is turned on before attempting to send any kind of AT commands to the Parani-SD. Then launch HyperTerminal, it can usually be found in start >programs >accessories >communication >HyperTerminal. Select the Serial port that Parani-SD is connected to.

Select the Serial port setting in the window displayed, please make sure the serial settings in Hyperterminal are set to the same settings as the Parani-SD's serial settings.

To view the AT commands that are being typed, you will need to enable the local echo option. Go to File->Properties->Settings->ASCII setup and select the "Echo typed characters locally" option.

For expanded AT commands, please refer to Appendix A. AT commands.

Example of AT commands:

```
at+btinfo?
000195000002,PSD100v1.1.3-000002,MODE0,STANDBY,0,0,NoFC
OK
atd 000195000001
OK
CONNECT 000195000001
```

4. Approval Information

4.1. FCC

4.1.1. FCC Compliance Statement

This device complies with part 15 of the FCC Rules. Operation is subject to the following two conditions:

- (1) This device may not cause harmful interference, and
- (2) This device must accept any interference received,
Including interference that may cause undesired operation

4.1.2. RF Exposure Statement

The equipment complies with FCC RF radiation exposure limits set forth for an uncontrolled environment. This device and its antenna must not be co-located or operation in conjunction with any other antenna or transmitter.

4.1.3. Do not

Any changes or modifications to the equipment not expressly approved by the party responsible for compliance could void user's authority to operate the equipment.

4.2. CE

4.2.1. EC-R&TTE Directive

EN 50385
EN 60950
EN 301 489-1/-17
EN 300 328

4.3. MIC

4.4. Telec

4.5. SIG

5. RF Information

5.1. Radio Frequency Range

2.402~2.480GHz

5.2. Number of Frequency Channel

79 channels

5.3. Transmission Method

FHSS(Frequency Hopping Spread Spectrum)

5.4. Modulation Method

GFSK(Gaussian-filtered Frequency Shift Keying)

5.5. Radio Output Power

Products	Radio Output Power
Parani-SD100	+18dBm
Parani-SD200	+4dBm

5.6. Receiving Sensitivity

Products	Radio Output Power
Parani-SD100	-88dBm
Parani-SD200	-80dBm

5.7. Power Supply

Products	Radio Output Power
Parani-SD100	DC5.0~12V
Parani-SD200	DC5.0~12V

Appendix A: Connections

A.1. Serial Port Pin Outs

Parani-SD is a DCE device compatible with the RS232 standard, a DB9 female interface.

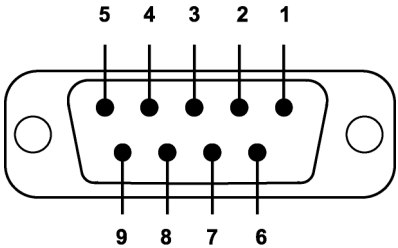

Figure A-1 Pin layout of the DB-9 female connector

Table A-1. Pin assignment of the DB-9 female connector

Pin #	Signal	Direction	Description
1	DCD	Output	Bluetooth Connect Detect
2	TxD	Output	Transmitted Data
3	RxD	Input	Received Data
4	DSR	Input	DTE Ready
5	GND	-	Signal Ground
6	DTR	Output	DCE Ready
7	CTS	Input	Clear to Send
8	RTS	Output	Request to Send
9	Vcc	Input	(5V~12V)

A.2. Serial Wiring Diagram

A.2.1. To Host with DTE Interface

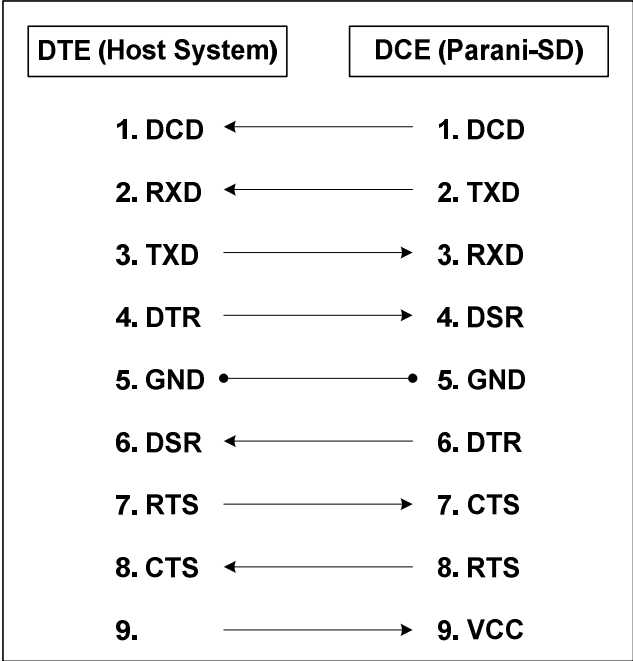

A.2.2. To Host with DCE Interface

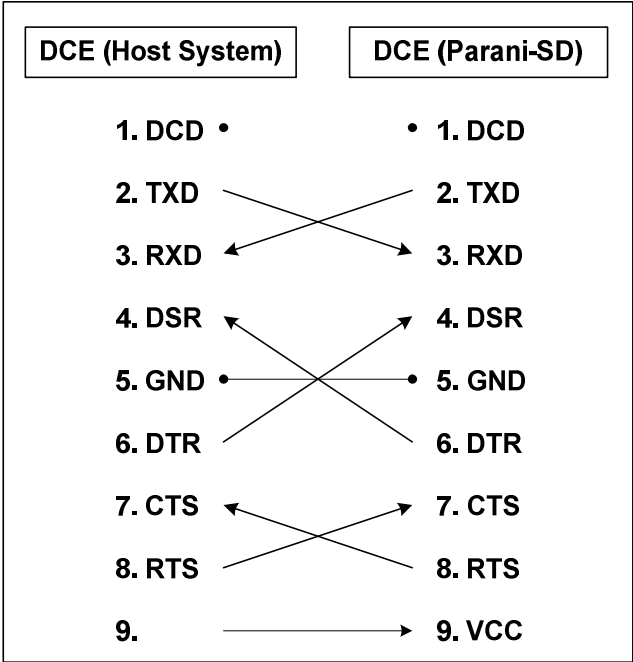

Appendix B: AT Commands

B.1. Terminology

B.1.1. AT Command

AT command set is the in fact standard language for controlling modems. The AT command set was developed by Hayes and is recognized by virtually all personal computer modems. Parani-SD provides the extended AT command set to control and configure the serial parameters and Bluetooth connection.

B.1.2. AT Response

Parani-SD replies to AT commands with 4 kinds of message, 'OK', 'ERROR', 'CONNECT' and 'DISCONNECT'.

B.1.3. Operation Mode

Mode	Description
Mode0	Waiting for AT commands
Mode1	Attempting to connect the last connected Bluetooth device
Mode2	Waiting for the connection from the last connected Bluetooth device
Mode3	Waiting for the connection from any other Bluetooth device

B.1.4. Operation Status

Status	Description
Standby	Waiting for AT commands
Pending	Executing tasks
Connect	Transmitting data

B.1.5. Security

Security	Description
Authentication	Pin Code (or Pass key)
Encryption	Data encryption

B.1.6. Symbols

The symbols are used for the description of command syntax as follows:

Symbols	Meaning	ASCII Code
↵	Carriage return	0x0D
↵	Line feed	0x0A
↵↵	Carriage return + Line feed	
112233445566	Bluetooth device address	
N or m	One digit decimal number	
to	Timeout in seconds	

B.2. Command Category

Command Category	Index	AT Commands					
RESET	1 2	ATZ AT&F					
SERIAL PORT	3 4	AT AT+UARTCONFIG,b,p,s					
BLUETOOTH	Information	5 6 7 8 9	AT+USEDIP? AT+BTINFO? AT+BTINQ? AT+BTLAST? AT+BTVER?				
		Mode	10	AT+BTMODE,n			
		Status	11 12 13 14 15 16 17	+++ AT+SETESC,nn ATO AT+BTCANCEL AT+BTSCAN AT+BTSCAN,n,to AT+BTSCAN112233445566,to			
			Connection	18 19 20 21 22	ATD ATD112233445566 ATA ATA112233445566 ATH		
				Security	23 24 25 26 27	AT+BTKEY=\$string AT+BTSD? AT+BTCSD AT+BTFP,n AT+BTSEC,a,e	
	Miscellaneous				28 29 30	AT+BTNAME=\$string AT+BTLPM,n AT+BTRSSI,n	
					S-REGISTER	31 32 33	AT&V ATSnn? ATSnn=mm

B.3. Command Description

B.3.1. ATZ↵

Response	↵OK↵
Purpose	Software Reset
Description	This has the same effects as Powercycling the unit. This command disconnects any connected Bluetooth device, and stops ongoing tasks. After rebooting, the status will be decided by the preset operation mode. Some AT commands require the ATZ command be run so that the commands can take effect.
Reference	AT&F, AT+BTCSD, AT+UARTCONFIG

B.3.2. AT&F↵

Response	↵OK↵
Purpose	Hardware reset
Description	This has the same effect as initialization by pressing the factory reset button. All parameters are initialized to factory defaults.
Reference	ATZ

B.3.3. AT↵

Response	↵OK↵
Purpose	Check the connection status with host equipment
Description	Check if the connection to host equipment is operating normally. The serial parameters of Parani-SD must be same as those of host equipment. If not, the Parani-SD will not respond or 'ERROR' message will appear or an abnormal sequence of strings will appear.
Reference	AT+UARTCONFIG, ATZ, AT&F

B.3.4. AT+UARTCONFIG,Baudrate,Parity,Stopbit↵

Response	↵OK↵
Purpose	Set Serial parameters
Parameters	Baudrate=1200/2400/9600/14400/19200/38400/57600/115200/230400 (Default=9600) Parity=N/E/O (Default=N) Stopbit=1/2 (Default=1)
Description	The Serial parameters can be set or changed only if SW config mode is selected in dip switch. The factory default is 9600, N, 1. To take effect the ATZ command must be used or Powercycle the unit.
Reference	AT, ATZ, AT&F, ATS
Example	AT+UARTCONFIG,9600,N,1

B.3.5. AT+USEDIP?↵

Response	↵m↵
Purpose	Check the Baud rate set by the dip switch
Description	m=0: Dip switches are set to 'S/W Config' m=1: Please view the dipswitches to view your baud rate.
Reference	AT, ATZ, AT&F, ATS

B.3.6. AT+BTINFO?↵

Response	↵112233445566,DeviceName,Mode,Status,Auth,Encryp,FlowControl↵ ↵OK↵
Purpose	Display Bluetooth settings
Description	The current Bluetooth settings are displayed including BD address, Device name, Operation mode, Operation status, Authentication, Data Encryption, and Hardware Flow Control. The initial value of Device name is 'PSD100v1.1.3-445566'. PSD stands for Parani-SD, v1.1.3 for the version of firmware, and 445566 for the last 6 digits of BD address. Mode=MODE0/MODE1/MODE2/MODE3 Status=STANDBY/PENDING/CONNECT Auth=0/1 (Authentication is not activated when 0) Encrypt=0/1 (Encryption is not activated when 0) FlowControl=HWFC/NoFC
Reference	AT+BTNAME, AT+BTMODE, AT+BTSEC, ATS14?

B.3.7. AT+BTINQ?↵

Response	↵112233445566,FriendlyName,CoD↵ ↵112233445566,FriendlyName,CoD↵ ↵112233445566,FriendlyName,CoD↵ ↵OK↵
Purpose	Search Bluetooth devices nearby
Description	The Bluetooth devices in Inquiry scan mode nearby are displayed with their BD addresses, Device names, and Class of device. Maximum 15 devices are scanned for 30 seconds. (Default 10 value in S-register 6)
Reference	AT+BTSCAN, ATD, AT+BTINFO?

B.3.8. AT+BTLAST?↵

Response	↵112233445566↵
Purpose	Display the BD address of the last connected device
Description	The Bluetooth device last connected to this Parani-SD is displayed with its BD address.
Reference	AT+BTSCAN, ATD, AT+BTINFO?, AT+BTINQ?

B.3.9. AT+BTVER?

Response	↵SD100v1.1.3↵ ↵OK↵
Purpose	Display device firmware version
Description	Display device firmware version
Reference	AT+BTINFO?

B.3.10. AT+BTMODE,n

Response	↵OK↵
Purpose	Set operation mode
Parameters	n=0: MODE0 (Default) n=1: MODE1 n=2: MODE2 n=3: MODE3
Description	When the operation status is 'Pending' currently, change the status to 'Standby' with AT+BTCANCEL prior to this command. To take effect the ATZ must be executed or Powercycle the unit
Reference	AT+BTINFO?
Example	AT+BTMODE,2 ↵OK↵ ATZ

B.3.11. +++

Response	↵OK↵
Purpose	Convert the operation status of 'Connect' to 'Standby'
Description	In 'Connect' status, data from host is transmitted to the other side Bluetooth device, and any AT command is not accepted but this command, which is not echoed on the screen. When Parani-SD encounters a character '+' from host, it stops the data transmission and waits for next 2 characters. If the next 2 characters aren't both '+', it restart to transmit data including the first '+' as well. If not, it converts the operation status to 'Standby'. If the data from host includes '+++', it will convert the operation status to 'Standby'. Notice that Parani-SD holds data transmission when it encounters '+', until receiving next character. '+' is an escape sequence character by default, which is changeable by AT+SETESC.
Reference	AT+SETESC, ATO, AT+BTCANCEL

B.3.12. AT+SETESC,nn

Response	↵OK↵
Purpose	Change the escape sequence character
Description	Escape sequence character set to '+' by default is changeable. The parameter nn must be a printable character.

Reference	+++ , ATO
Example	AT+SETESC,42

B.3.13. ATO

Response	None
Purpose	Convert the operation status of 'Standby' to 'Connect'
Description	You can convert the operation status of 'Standby' to 'Connect' ready to transmit data.
Reference	+++ , AT+SETESC

B.3.14. AT+BTCANCEL

Response	OK
Purpose	Terminate the current task
Description	This terminates a current executing task, such as Inquiry scan and Page scan, then converts the operation status to 'Standby'
Reference	AT+BTSCAN, ATD, AT+BTINQ?

B.3.15. AT+BTSCAN

Response	OK CONNECT 112233445566
Purpose	Wait for inquiry and connection from other Bluetooth devices
Description	This allows the inquiry and connection from the other Bluetooth devices. The operation status will be in 'Pending' after this command. When connection is made and released, the operation status is back set to 'Pending'. To convert the operation status to 'Standby' AT+BTCANCEL must be used. This has the same effect as AT+BTSCAN,3,0. When a connection is made with another Bluetooth device, response will be 'CONNECT' with its BD address.
Reference	ATD, AT+BTINQ?, AT+BTCANCEL

B.3.16. AT+BTSCAN,n,to

Response	OK CONNECT 112233445566 or OK ERROR
Purpose	Wait for inquiry and connection from other Bluetooth devices for a given duration
Parameters	n=1: Allows Inquiry scan n=2: Allows Page scan n=3: Allows both of Inquiry scan and Page scan to= Time duration in seconds

Description	For the given to, Parani-SD is waiting for the inquiry and connection from other Bluetooth devices. If the parameter of to is 0, it will wait forever. When connection is made with other Bluetooth device, response will be 'CONNECT' with its BD address. If there is no connection made within this time duration, response is 'ERROR' and the operation status becomes to 'Standby'.
Reference	ATD, AT+BTINQ?, AT+BTCANCEL
Example	AT+BTSCAN,2,30

B.3.17. AT+BTSCAN112233445566,to

Response	↵OK↵ ↵CONNECT 112233445566↵ or ↵OK↵ ↵ERROR↵
Purpose	Wait for connection by a Bluetooth device with a given BD address
Parameters	112233445566=BD address to= time duration in seconds
Description	Parani-SD will wait to be connected to by the Bluetooth device with the given BD address. If the parameter of to is 0, it will wait forever. When connection is made with the Bluetooth device, response will be 'CONNECT' with its BD address. If there is no connection made within this time duration, response is 'ERROR' and the operation status becomes 'Standby'.
Reference	ATD, AT+BTINQ?, AT+BTCANCEL
Example	AT+BTSCAN000B530011FF,30

B.3.18. ATD

Response	↵OK↵ ↵CONNECT 112233445566↵ or ↵OK↵ ↵ERROR↵
Purpose	Connect to the last connected Bluetooth device
Description	Parani-SD saves the BD address of the Bluetooth device most recently connected to. If it fails to make a connection, response will display an 'ERROR'.
Reference	AT+BTINQ?, AT+BTSCAN

B.3.19. ATD112233445566

Response	↵OK↵ ↵CONNECT 112233445566↵ or ↵OK↵ ↵ERROR↵
Purpose	Connect to a specific Bluetooth device with a given BD address
Parameters	112233445566 = BD address

Description	Parani-SD attempts to connect to the Bluetooth device with the given BD address. To make successful connection, the Bluetooth device must be in Page scan mode. This attempt continues for 5 minutes. If it fails to make connection, response is 'ERROR '.
Reference	AT+BTINQ?, AT+BTSCAN
Example	ATD000B530011FF

B.3.20. ATA

Response	↵OK↵ ↵Start ACL Open↵ ↵ACL Connect Success↵ or ↵ACL Connect Fail↵
Purpose	ACL connect to the last connected Bluetooth device
Description	If it make connection, response will display an 'ACL Connect Success', and if fail to connection, display 'ACL Connection Fail'. Must have reboot for new ACL connection.

B.3.21. ATA112233445566

Response	↵OK↵ ↵Start ACL Open↵ ↵ACL Connect Success↵ or ↵ACL Connect Fail↵
Purpose	ACL connect to a specific Bluetooth device with a given BD address
Parameters	112233445566 = BD address
Description	Parani-SD attempts to ACL connect to the Bluetooth device with the given BD address. To make successful ACL connection, the Bluetooth device must be in Page scan mode. If it make connection, response will display an 'ACL Connect Success', and if fail to connection, display 'ACL Connection Fail'. Must have reboot for new ACL connection.
Example	ATA000B530011FF

B.3.22. ATH

Response	↵OK↵ ↵DISCONNECT↵
Purpose	Release the current connection
Description	The current Bluetooth connection will be disconnected. It takes about 30 seconds to detect an abnormal disconnection such as power off and moving out of service range.
Reference	ATD, AT+BTSCAN

B.3.23. AT+BTKEY=\$string

Response	↵OK↵
Purpose	Change pin code
Parameters	\$string= New pin code (Default="1234")

Description	Pin code is a string, which allows up to 16 alpha-numeric characters. Based on this pin code, Parani-SD generates a link key which is used in actual authentication process
Reference	AT+BTCSD, AT+BTFP, AT+BTSD?, AT+BTSEC, ATZ, AT&F
Example	AT+BTKEY="apple"

B.3.24. AT+BTSD? ↵

Response	↵112233445566↵ ↵OK↵
Purpose	Display a list of Bluetooth devices sharing the same pin code
Description	Once a connection is made with a pin code, Parani-SD saves the Bluetooth device with its link key, generated by the pin code. The connection to a device listed in Parani-SD can be made automatically without the authentication process. The maximum number kept on the list is 5.
Reference	AT+BTCSD, AT+BTFP, AT+BTKEY, AT+BTSEC, ATZ, AT&F

B.3.25. AT+BTCSD ↵

Response	↵OK↵
Purpose	Clear the list of Bluetooth devices sharing the same pin code
Description	This clears the list of Bluetooth devices linked with the same key in flash memory. To take effect the ATZ command must be used or Powercycle the unit.
Reference	AT+BTFP, AT+BTKEY, AT+BTSD?, AT+BTSEC, ATZ, AT&F

B.3.26. AT+BTFP,n ↵

Response	↵OK↵
Purpose	Set generation of link key every time of connection
Parameters	n=0: Inactivate (Default) n=1: Activate
Description	If n is set to 1, Parani-SD asks for the pin code every time a connection is made. This can be used to increase security.
Reference	AT+BTCSD, AT+BTKEY, AT+BTSD?, AT+BTSEC, ATD, ATZ, AT&F

B.3.27. AT+BTSEC,Authentication,Encryption ↵

Response	↵OK↵
Purpose	Set authentication and data encryption
Parameters	<i>Authentication</i> =0: Inactivate (Default) <i>Authentication</i> =1: Activate <i>Encryption</i> =0: Inactivate (Default) <i>Encryption</i> =1: Activate

Description	If the authentication is activated, the pin code must be set by AT+BTKEY command. Data encryption cannot be used when authentication is not enabled, i.e. <i>Authentication=0</i> and <i>Encryption=1</i> will not work properly.
Reference	AT+BTCSD, AT+BTFP, AT+BTSD?, AT+BTSD?, ATZ, AT&F

B.3.28. AT+BTNAME=\$string↵

Response	↵OK↵
Purpose	Change device name
Parameters	\$string= New device name (Default="PSDv1.1.3-445566")
Description	Parani-SD can have a user friendly name for easy identification. The name allows up to 30 alpha-numeric characters.
Reference	AT+BTINFO?, AT+BTINQ?
Example	AT+BTNAME="My-Parani-SD"

B.3.29. AT+BTLPM,n↵

Response	↵OK↵
Purpose	Set low power mode
Parameters	n=0: Inactivate (Default) n=1: Activate
Description	During no data transmission, Parani-SD can be in low power mode to save the power. It takes a few seconds to wake the Parani-SD out of low power mode.

B.3.30. AT+BTRSSI,n↵

Response	↵OK↵ ↵0,255,0,0↵ (repeatedly)
Purpose	Test signal strength
Parameters	n=0: Stop signal strength test n=1: Start signal strength test
Description	When Bluetooth connection is established, you can use this command in Standby status. The signal strength will be displayed repeatedly in order of Status, LinkQuality, Status, RSSI. If the LinkQuality is close to 255 and RSSI is close to 0, the signal strength is in good standing.
Example	+++ AT+BTRSSI,1 ↵OK↵ 0,255,0,0

B.3.31. AT&V↵

Response	↵S0:m0;S1:m1; ...Sn:mn↵ ↵OK↵
Purpose	Display all the S-registers
Description	All parameters are stored at S-register in flash memory. These values are sustained until a hardware reset.
Reference	ATS

B.3.32. ATSn↵ ↵

Response	↵value↵ ↵OK↵
Purpose	Display a given S-register
Parameters	nn= Address of S-register
Description	A specific S-register will be displayed.
Reference	AT&V

B.3.33. ATSn=mm↵

Response	↵OK↵
Purpose	Change S-register value
Parameters	nn= Address of S-register mm= New value of S-register
Description	Some S-registers are optimized for the overall performance and is protected and cannot be changed. When users try to change these S-registers, response is 'ERROR'. For details of S-register, refer Appendix. B.
Reference	AT&V
Example	ATS10=0

B.4. Command Validity

AT Command	Operation Status		
	Standby	Pending	Connect
AT	○	○	
ATZ	○	○	
AT&F	○	○	
AT+BINQ?	◎		
ATD112233445566	◎		

ATD	⊙		
ATA112233445566	⊙		
ATA	⊙		
AT+BTSCAN	⊙		
AT+BTSCAN,n,to	⊙		
AT+BTSCAN112233445566,to	⊙		
AT+BTCANCEL		○	
+++			○
AT+SETESC	⊙		
ATO	●		
ATH	●		
AT+BTSEC,Auth,Encr	⊙		
AT+BTLAST?	○	○	
AT+BTMODEn	⊙		
AT+BTNAME="Name"	⊙		
AT+BTKEY="nnnn"	⊙		
AT+BTINFO?	○		
AT+BTLPM,n	⊙		
AT+BTSD?	○	○	
AT+BTCSD	⊙		
AT+BTFP,n	⊙		
AT+UARTCONFIG,b,p,s	⊙		
AT+USEDIP?	○	○	
AT+BTVER?	○	○	
AT+BTRSSI,n	●		

⊙ Valid only when Parani-SD is not connected to other Bluetooth device.

● Valid only when Parani-SD is connected to other Bluetooth device.

Appendix C: S-Register

S-registers contains 52 parameters for the Parani-SD Series. These are stored in flash memory and the values will be saved unless hardware reset is executed. The value of S-register can be accessed and changed with ATS command. Some S-registers not shown below are set to maximize the performance of Parani-SD Series. Thus it is not recommended to change these S-registers. Changing the values of S-register can only be done in the Standby mode. Turn Parani-SD off and on.

C.1. S1: Force to Reconnect (default 1)

S1=0, Parani-SD in Mode1 does not try to reconnect when disconnected.
S1=1, Parani-SD in Mode1 keeps trying to reconnect when disconnected.

C.2. S3: Stream UART Policy (default 0)

S3=0, the priority of UART streaming is throughput.
S3=1, the priority is latency, which minimizes the delay of data transmission. This is useful in case of transmitting very small data quickly.
When this value is 1, in order to minimize latency, Parani-SD sends the received data immediately. When this value is 0, the Parani-SD maximizes throughput, the Parani-SD stores received data for a short time and sends a large data packet. If the packet length is less than 100 bytes, having latency being the priority is recommended. If the packet length is more than 100 bytes, having throughput as the priority is recommended. Also, if you want to use high baudrate, throughput priority will be more effective. Just for reference, the buffer length for receiving data is 2 Kbytes.

C.3. S4: Enable Remote Name Query (default 1)

S4=0, Parani-SD will query only the BD address. This speeds up the inquiry process.
S4=1, Parani-SD will query the BD address, device name and class of device.
When this value is 1, Parani-SD finds not only BD address but also friendly name. When this value is 0, Parani-SD finds only BD address. When set to 0 this will make queries much faster. When using the pairing button, finding friendly name will be omitted automatically.

C.4. S6: Enable Low Power Mode (default 0)

S6=0, deactivate Low Power Mode.
S6=1, activate Low Power Mode.
This value decides whether Parani-SD works in Low Power Mode or not. When this value is 0, Parani-SD works only in active power mode. When Parani-SD works in Low Power mode, delay in transferring data may occur.

C.5. S10: Enable Response Message (default 1)

S10=0, Parani-SD does not send response messages to the host system.
S10=1, Parani-SD sends response messages to host system.
This value decides whether Parani-SD sends response messages such as OK, ERROR, CONNECT, DISCONNECT or not. When this value is 0, Parani-SD will not send any response messages. If the response messages conflicts with your host programs or devices that is connected to Parani-SD, change this value to 0.

C.6. S11: Enable Escape (default 1)

S11=0, Parani-SD does not allow escape sequence characters. The operation status of Connect cannot be changed to Standby. Since the Parani-SD skips the process of detecting escape sequence characters, more efficient data transmission can be had.
S11=1, Parani-SD allows for the escape sequence character. Whenever it is needed, the Connect status can be changed to Standby.

C.7. S12: Clear Data Buffer When Disconnected (default 0)

S12=0, Parani-SD does not clear the data buffer when disconnected.
S12=1, Parani-SD clears the data buffer when disconnected.

C.8. S13: Enable DCD Signal (default 1)

S13=0, DCD signal off
S13=1, DCD signal on

C.9. S14: Enable DTR Transfer (default 1)

S14=0, DTR/DSR signal is transferred in a loop-back fashion.
S14=1, DTR signal is transferred to DSR of remote device.

C.10. S15: Enable Disconnect by DTR (default 0)

S15=0, DTR signal cannot release the connection.
S15=1, The Bluetooth connection can be released when DTR signal is off.
This value decides whether Bluetooth connection is released when DTR signal drops or not. If this value is 1, you can use DTR signal in order to disconnect Bluetooth connection.

C.11. S22: Faster Connection (default 0)

S22=0, none
S22=1, page scan
S22=2, inquiry scan
S22=3, page/inquiry scan

C.12. S23: Intercharacter Timeout Setting (default 0)

S23=0 : Not used
S23=1 : 1 x S26
S23=2 : 10 x S26
S23=3 : 100 x S26
Connecting time is average 1.5sec faster than normal mode.

C.13. S24: Maximum Number of Inquiry Result (default 10)

The maximum number of inquiry list can be controlled. This value is up to 15.

C.14. S26: Intercharacter Timeout (default 0)

S23=1 x S26=50 : Timeout-> 50msec
S23=2 x S26=50 : Timeout-> 500msec
S23=3 x S26=3 : Timeout-> 300msec

Intercharacter Timeout	* Optimal Value(S23 x S26)
50ms	180
100ms	235
200ms	340

* When 10 bytes data are sent every intercharacter timeout, they are sent separately by 10 bytes at the optimal value. If the intercharacter timeout is set below the optimal value, the data will be put together and sent by 20, 30, 40 bytes or more.

C.15. S28: Escape Sequence Character (default 43)

The decimal number of the ASCII code of escape sequence character can be controlled. The initial value is 43, the ASCII code of '+'.
The data will be put together and sent by 20, 30, 40 bytes or more.

C.16. S31: Page Timeout (default 300)

This is the timeout in seconds to attempt connection with the ATD command. After this timeout expires, the Parani-SD will restart automatically. If this value is 0, Parani-SD will attempt to connect without restarting

C.17. S33: Inquiry Timeout (default 30)

This is the timeout in seconds to execute inquiry scan.

C.18. S37: Supervision Timeout (default 16000)

This is the timeout in 625µsec to presume disconnection, which is set to 16000 initially. $16000 \times 625\mu\text{sec} = 10\text{sec}$

The smaller the value becomes, the more quickly Parani-SD can detect an abnormal disconnection. But when the communication is suspended, it may be regarded as disconnection.

C.19. S43: COD (default 001F00)

This is the value of COD. Default value is 001F00(Uncategorized, specific device code not specified).

C.20. S44: COD Filter (default 000000)

This is the value of inquiry COD filter.

Ex) ats44=001c00

C.21. S45: IAC(Inquiry access code)

The reserved IAC addresses are 0x9E8B00 ~ 0x9E8B3F. The general inquiry IAC is 0x9E8B33. So default value is 0x9E8B33.

C.22. S46: BD Address of Last Connected Device

This saves the BD address of the Bluetooth device connected most recently.

C.23. S47: Select Low Power Mode (default 0)

S47=0, Select Park Mode

S47=1, Select Sniff Mode

When this value is 0, Parani-SD works only in park mode. When Parani-SD works in park mode, delay in transferring data may occur. And if the value is 1, Parani-SD works in sniff mode. Parani-SD works always low power mode but the data will be put together.

C.24. S48: Low Power Max Interval (default 2048)

This is the max interval value to use low power mode, which is set to 2048 initially. ($2048 \times 625\mu\text{sec} = 1280\text{msec}$)

C.25. S49: Low Power Min Interval (default 800)

This is the min interval value to use low power mode, which is set to 800 initially. ($800 \times 625\mu\text{sec} = 500\text{msec}$)

When sniff mode, a small sniff interval increases power consumption, a large sniff interval increases latency. For low power modes, typical values of the sniff interval are from about 0.5 second to 1.28 seconds

C.26. S50: Low Power Sniff Attempt (default 8)

This is the sniff attempt value, which is set to 8 initially. ($8 \times 0.625\mu\text{sec} = 5\text{msec}$)

C.27. S51: Low Power Sniff Timeout (default 8)

This is the sniff timeout value, which is set to 8 initially. ($8 \times 0.625\mu\text{sec} = 5\text{msec}$)

The sniffing slave listens for traffic during the sniff slots determined by the sniff attempt parameter. If no message addressed to the sniffing slave is received, the sniffing slave ceases listening for packets. If a message with the sniffing slave's active member address is received, it continues listening for further sniff timeout slots after the sniff slot.

C.28. S52: Low Power Park Timeout (default 5)

This is the park timeout value, which is set to 5 initially. (5sec)

During no data transmission in park timeout, Parani-SD can be in low power mode to save the power. It takes a few seconds to wake the Parani-SD out of low power mode.

Appendix D: Trouble Shooting

D.1. No Data Transmission

D.1.1. COM Port Settings

Check whether the Baud rate of Parani-SD matches that of its host equipment.

Check whether the host equipment has a Data bit setting of 8. Parani-SD supports only 8 Data bit settings. If your host equipment uses 7 Data bit and even or odd parity, it may work with a 8 Data bit and No parity setting. This is valid only when both DCE devices are the Parani-SD. In this case, set both Parani-SDs to 8 Data bit and No parity. If one of DCE devices is another Bluetooth device such as Bluetooth USB dongle, 7 bit data configurations will not work.

Check whether the Parity and Stop bit of Parani-SD match those of your host equipment. Parani-SD supports No parity, Even parity and Odd parity, 1 and 2 Stop bit configurations.

Check whether the host equipment of Parani-SD uses Hardware Flow Control. Parani-SD is initially set to Use of Hardware Flow Control. If your host equipment does not use Hardware Flow Control, please disable the Hardware flow control option by way of the dipswitch.

Parani-SD does not support RS-232 break signal.

D.1.2. Pin Assignment

Parani-SD is a DCE device. If your host equipment is DTE, plug Parani-SD directly to the host equipment or use straight RS-232 cable. If your host equipment is DCE, use will need to use a cross over RS-232 cable (Null modem cable) or a Male to Male DB9 Null Modem adapter.

D.2. Data Loss or Malfunctioning

D.2.1. Hardware Flow Control

When transmitting large amounts of data with No Hardware Flow Control, Parani-SD may clear the data buffer unexpectedly. The possibility becomes greater as the RF transmission environment becomes worse.

D.2.2. Response Message

AT response messages from the Parani-SD may affect the host system unexpectedly. Do not use Parani-SD If your applications cannot allow for this wireless time delay.

D.3. Transmission Delay

D.3.1. RF Processing Delay

It takes 30msec approximately for a Parani-SD to complete a data transmission to the other Bluetooth device. This time delay cannot be reduced and may enlarge as the RF transmission environment becomes worse. Do not use Parani-SD If your applications cannot allow for this time delay.

D.3.2. RF Transmission Environment

If there are many Bluetooth devices working in a small area and/or the RF communication distance is too great and/or there are some obstacles affecting RF performance, the Parani-SD repeats the transmission packet by packet due to interferences and/or low RF performance. This may lead to increased data transmission time delays.

Appendix E: Parani-SD100/200 mechanical drawing

E.1. Parani-SD100 mechanical drawing

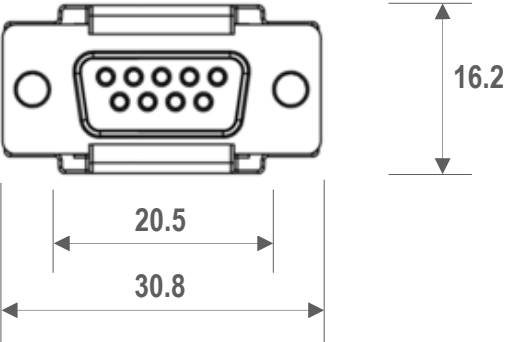
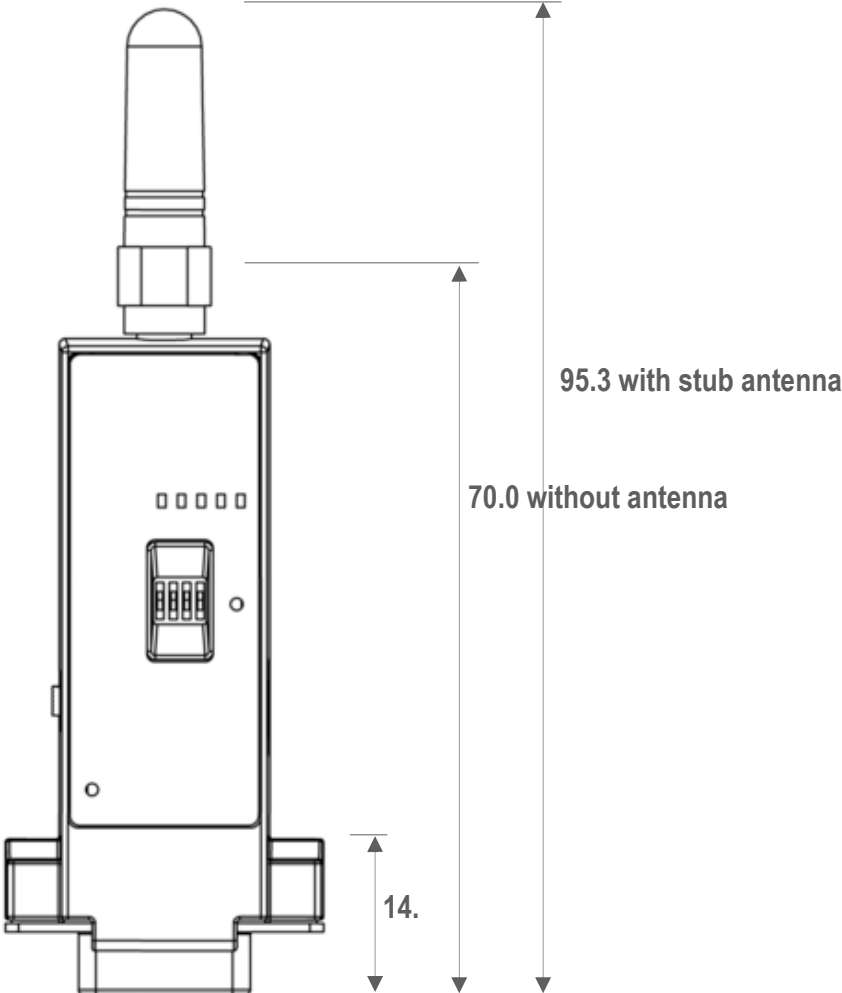

E.2. Parani-SD200 mechanical drawing

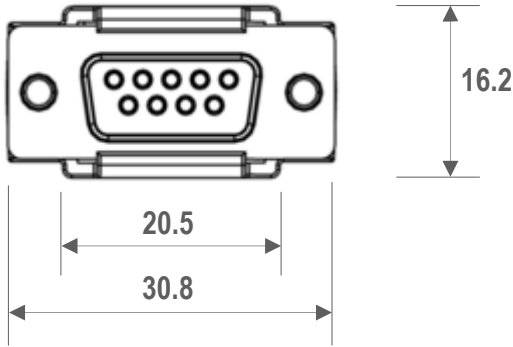
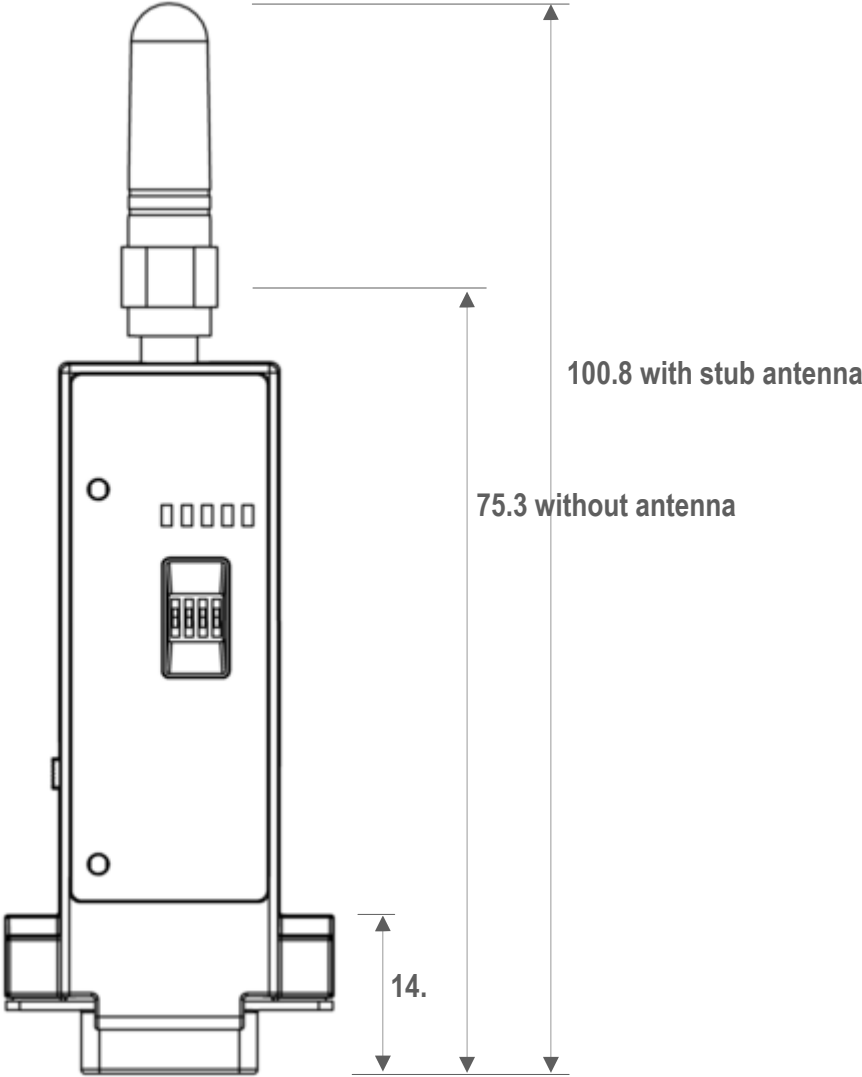

E.3. Parani-SD200 battery pack mechanical drawing

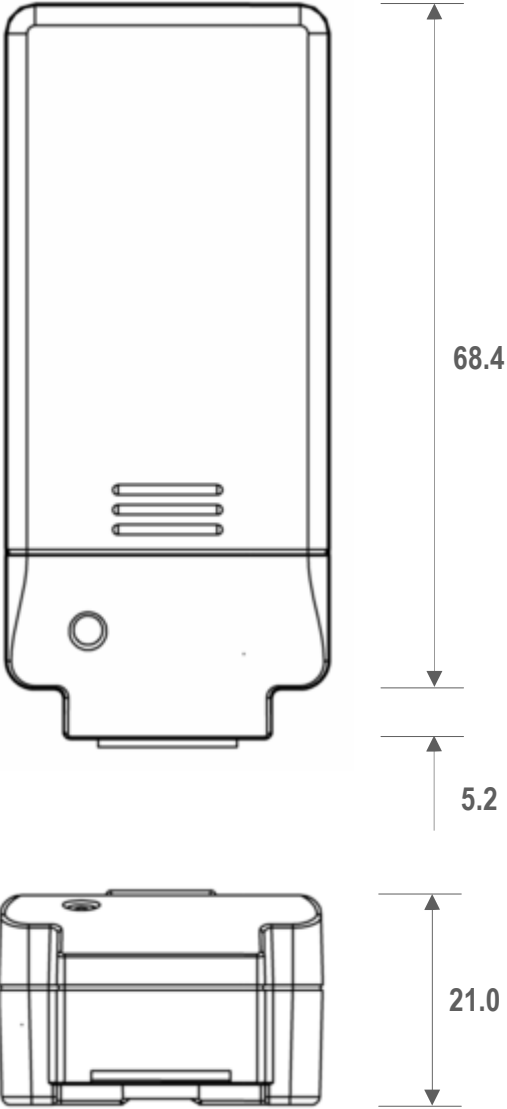

Appendix F: Warranty

F.1. GENERAL WARRANTY POLICY

Sena Technologies, Inc. (hereinafter referred to as SENA) warrants that the Product shall conform to and perform in accordance with published technical specifications and the accompanying written materials, and shall be free of defects in materials and workmanship, for the period of time herein indicated, such warranty period commencing upon receipt of the Product.

This warranty is limited to the repair and/or replacement, at SENA's discretion, of defective or non-conforming Product, and SENA shall not be responsible for the failure of the Product to perform specified functions, or any other non-conformance caused by or attributable to: (a) any misapplication or misuse of the Product; (b) failure of Customer to adhere to any of SENA's specifications or instructions; (c) neglect of, abuse of, or accident to, the Product; or (d) any associated or complementary equipment or software not furnished by SENA.

Limited warranty service may be obtained by delivering the Product to SENA or to the international distributor it was purchased through and providing proof of purchase or receipt date. Customer agrees to insure the Product or assume the risk of loss or damage in transit, to prepay shipping charges to SENA, and to use the original shipping container or equivalent.

F.2. LIMITATION OF LIABILITY

EXCEPT AS EXPRESSLY PROVIDED HEREIN, SENA MAKES NO WARRANTY OF ANY KIND, EXPRESSED OR IMPLIED, WITH RESPECT TO ANY EQUIPMENT, PARTS OR SERVICES PROVIDED PURSUANT TO THIS AGREEMENT, INCLUDING BUT NOT LIMITED TO THE IMPLIED WARRANTIES OF MERCHANTABILITY AND FITNESS FOR A PARTICULAR PURPOSE. NEITHER SENA NOR ITS DEALER SHALL BE LIABLE FOR ANY OTHER DAMAGES, INCLUDING BUT NOT LIMITED TO DIRECT, INDIRECT, INCIDENTAL, SPECIAL OR CONSEQUENTIAL DAMAGES, WHETHER IN AN ACTION IN CONTRACT OR TORT (INCLUDING NEGLIGENCE AND STRICT LIABILITY), SUCH AS, BUT NOT LIMITED TO, LOSS OF ANTICIPATED PROFITS OR BENEFITS RESULTING FROM, OR ARISING OUT OF, OR IN CONNECTION WITH THE USE OF FURNISHING OF EQUIPMENT, PARTS OR SERVICES HEREUNDER OR THE PERFORMANCE, USE OR INABILITY TO USE THE SAME, EVEN IF SENA OR ITS DEALER HAS BEEN ADVISED OF THE POSSIBILITY OF SUCH DAMAGES. IN NO EVENT WILL SENA OR ITS DEALERS TOTAL LIABILITY EXCEED THE PRICE PAID FOR THE PRODUCT.

F.3. HARDWARE PRODUCT WARRANTY DETAILS

WARRANTY PERIOD: SENA warranties embedded hardware Product for a period of one (1) year, and external hardware Product for a period of three (3) or five (5) years according to the Product type.

WARRANTY PROCEDURE: Upon return of the hardware Product SENA will, at its option, repair or replace Product at no additional charge, freight prepaid, except as set forth below. Repair parts and replacement Product will be furnished on an exchange basis and will be either reconditioned or new. All replaced Product and parts become the property of SENA. If SENA determines that the Product is not under warranty, it will, at the Customers option, repair the Product using current SENA standard rates for parts and labor, and return the Product at no charge in or out of warranty.

WARRANTY EXCLUSIONS: Damages caused by

- Accidents, falls, objects striking the SENA product,
- Operating the Product in environments that exceed SENA's temperature and humidity specifications,
- Power fluctuations, high voltage discharges,
- Improper grounding, incorrect cabling,
- Misuse, negligence by the customer or any other third party,
- Failure to install or operate the product (s) in accordance to their SENA User Manual,
- Failure caused by improper or inadequate maintenance by the customer or any other third party,
- Floods, lightning, earthquakes,

- Water spills,
- Replacement of parts due to normal wear and tear,
- Hardware has been altered in any way,
- Product that has been exposed to repair attempts by a third party without SENA's written consent,
- Hardware hosting modified SENA Software, or non-SENA Software, unless modifications have been approved by SENA.
- Battery component capacity degradation due to usage, aging, and with some chemistry, lack of maintenance.

F.4. SOFTWARE PRODUCT WARRANTY DETAILS

WARRANTY PERIOD: SENA warrants software Product for a period of one (1) year.

WARRANTY COVERAGE: SENA warranty will be limited to providing a software bug fix or a software patch, at a reasonable time after the user notifies SENA of software non-conformance.

F.5. THIRD-PARTY SOFTWARE PRODUCT WARRANTY DETAILS

The warranty policy of the third-party software is conformed to the policy of the corresponding vendor